



Chapter 4

Radio Communication Basics





Chapter 4

Radio Communication Basics



RF Spectrum

RF Spectrum

Table 4-1: Subdivision of the Radio Frequency Spectrum

<i>Transmission type</i>	<i>Frequency</i>	<i>Wavelength</i>
Very low frequency (VLF)	9–30 kHz	33–10 km
Low frequency (LF)	30–300 kHz	10–1 km
Medium frequency (MF)	300–3000 kHz	1000–100 m
High frequency (HF)	3–30 MHz	100–10 m
Very high frequency (VHF)	30–300 MHz	10–1 m
Ultra high frequency (UHF)	300–3000 MHz	1000–100 mm
Super high frequency (SHF)	3–30 GHz	100–10 mm
Extremely high frequency (EHF)	30–300 GHz	10–1 mm

Infrared (3-400THz): far(3-30), middle(30-120), near(120-400)

Visible light (400-800THz)

RF Spectrum

直進性が弱い

情報伝送容量が小さい

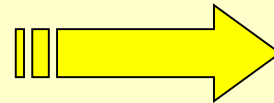
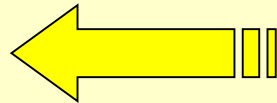

直進性が強い

情報伝送容量が大きい

同じ出力の場合、低い周波数の電波は遠くまで届くが、高い周波数の電波は遠くまで届かない

wavelength	100km	10km	1km	100m	10m	1m	10cm	1cm	1mm	0.1mm
frequency	3kHz	30kHz	300kHz	3MHz	30MHz	300MHz	3GHz	30GHz	300GHz	3THz

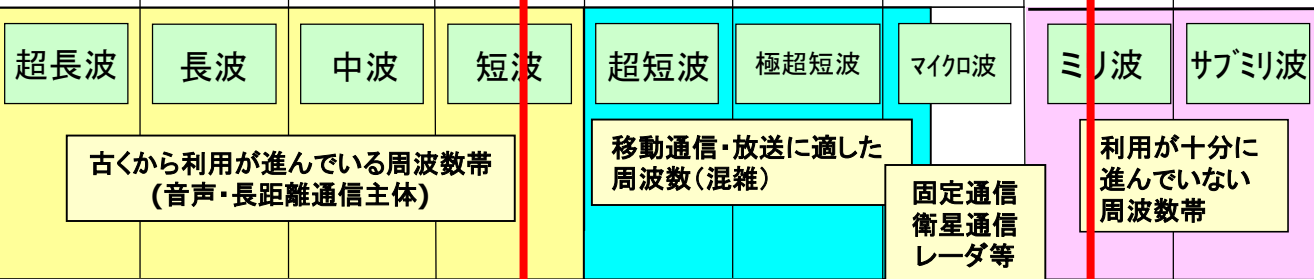

TV

Cellular

Wireless LAN

RF Spectrum

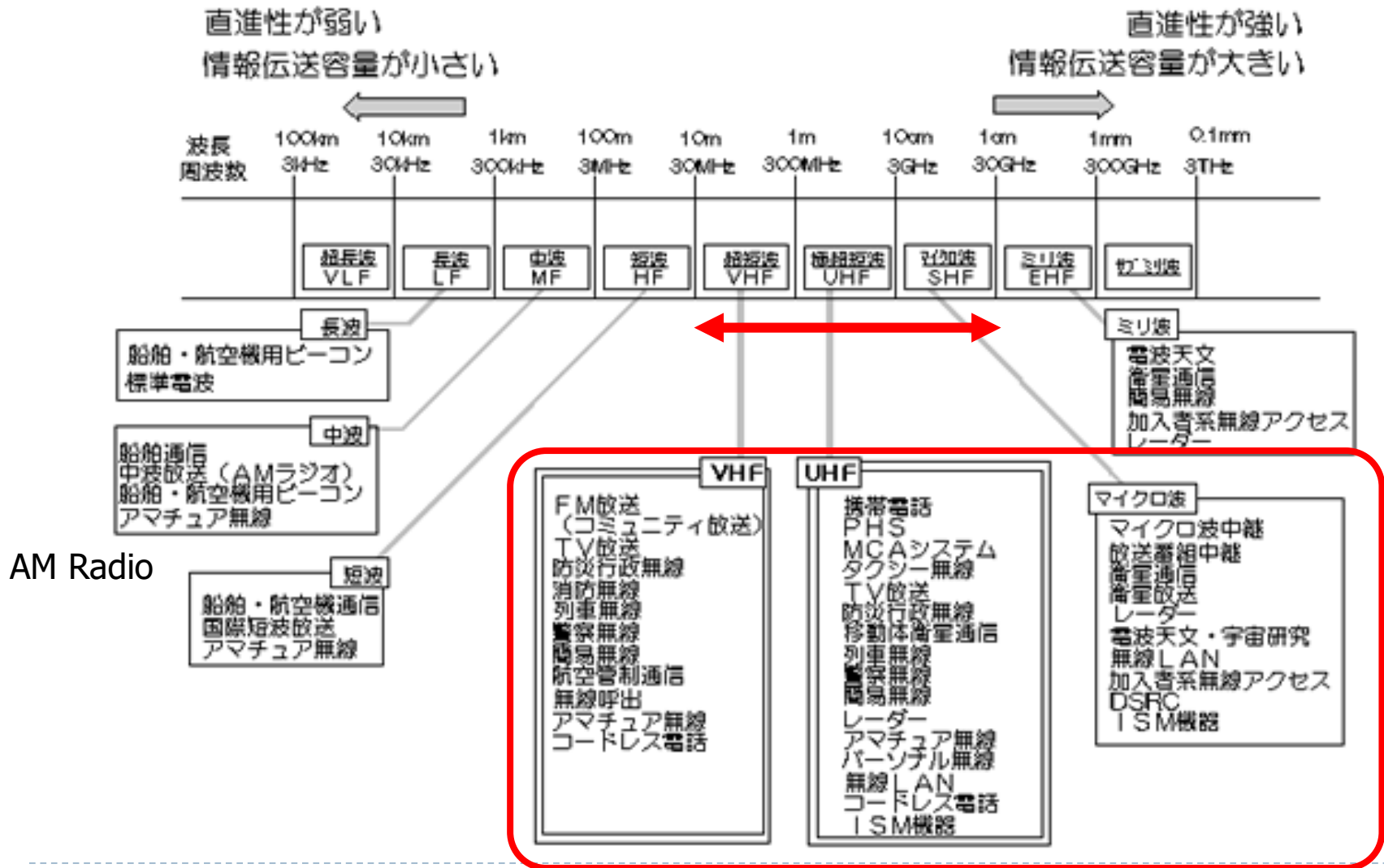

AM Radio

TV, FM Radio, Cellular, Wireless LAN/PAN/MAN, ...

RF Spectrum: 90~770MHz in Japan

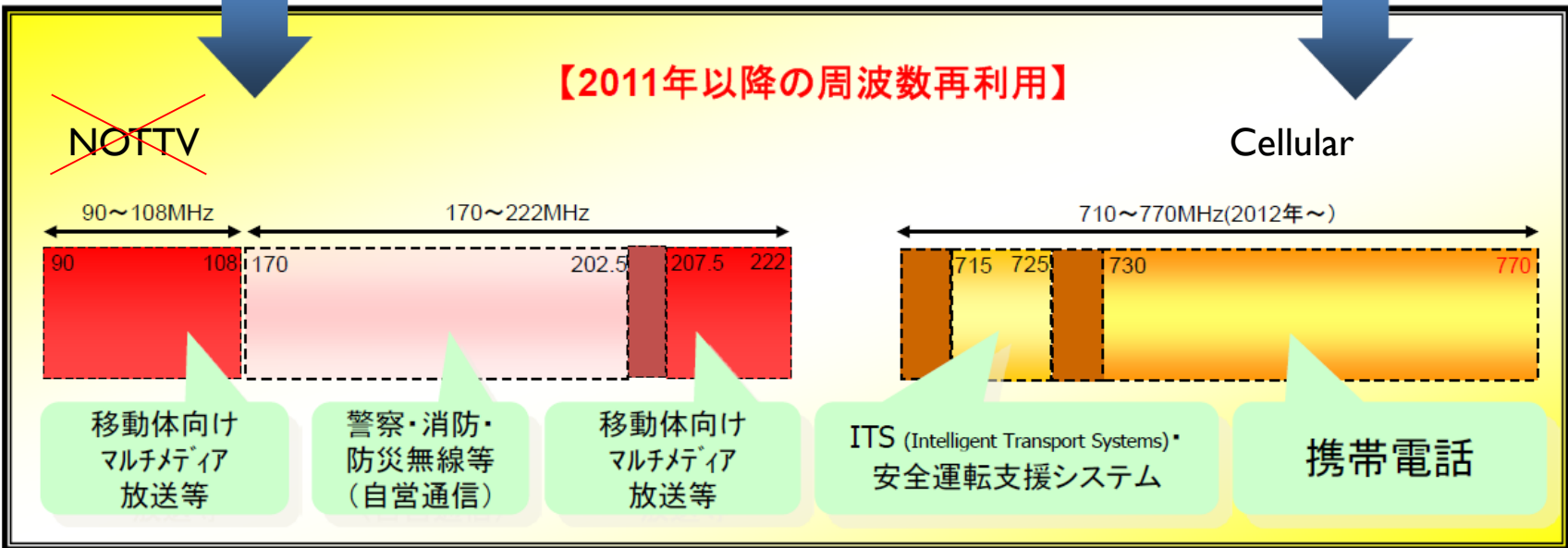
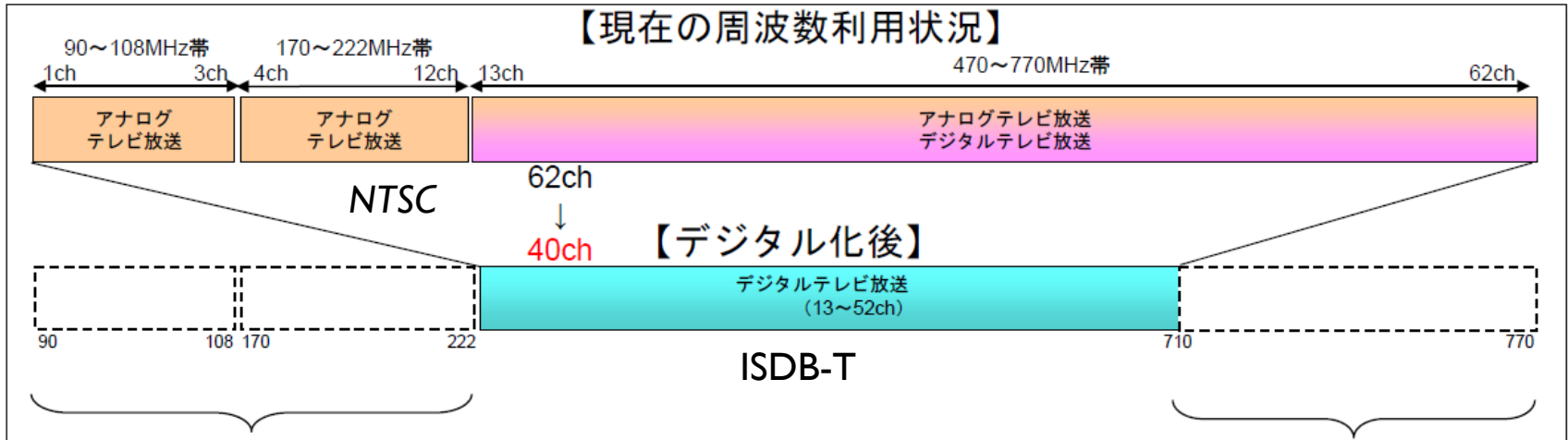

RF band allocation in Japan

- ▶ Cellular Phone (licensed):
 - ▶ 800MHz, 1.5GHz, 1.7GHz, 2GHz
- ▶ TV Broadcasting (licensed):
 - ▶ Terrestrial:
 - ▶ VHF (90-108MHz, 170-222MHz), UHF (470-770MHz)
 - ▶ Satellite:
 - ▶ BS (11.7-12.1GHz), CS (12.3-12.7GHz)
- ▶ Wireless LAN (unlicensed):
 - ▶ 2.4GHz (ISM band), 5GHz



RF bands for unlicensed wireless networking

Table 4-2: Radio Frequency Bands in Use for Wireless Networking

<i>RF band</i>	<i>Wireless networking specification</i>
915/868 MHz ISM	ZigBee
2.4 GHz ISM	IEEE 802.11b, g, Bluetooth, ZigBee
5.8 GHz	IEEE 802.11a

Table 4-4: 2.4 GHz ISM Band Regulatory Differences by Region

<i>Regulator</i>	<i>2.4 GHz ISM specifications</i>
FCC (USA)	1 W maximum transmitted power 2.402–2.472 GHz, 11 × 22 MHz channels
ETSI (Europe)	100 mW maximum EIRP 2.402–2.483 GHz, 13 × 22 MHz channels
ARIB (Japan)	100 mW maximum EIRP 2.402–2.497 GHz, 14 × 22 MHz channels

- ▶ unlicensed ISM band : Instrument, Scientific and Medical band
EIRP: equivalent isotropic radiated power

RF Networking Challenge

Table 4-6: The Radio Frequency Networking Challenge

<i>Challenges</i>	<i>Considerations and solutions</i>
Link reliability	Signal propagation, interference, equipment siting, link budget.
Media access	Sensing other users (hidden station and exposed station problems), Quality of service requirements.
Security	Wired equivalent privacy (WEP), Wi-Fi Protected Access (WPA), 802.11i, directional antennas.

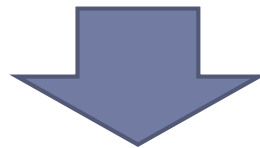

Popular and Future Standards for Wireless Communication



Hidden and Exposed Terminal Problems

- ▶ Hidden: out of transmission range
- ▶ Exposed: inside transmission range

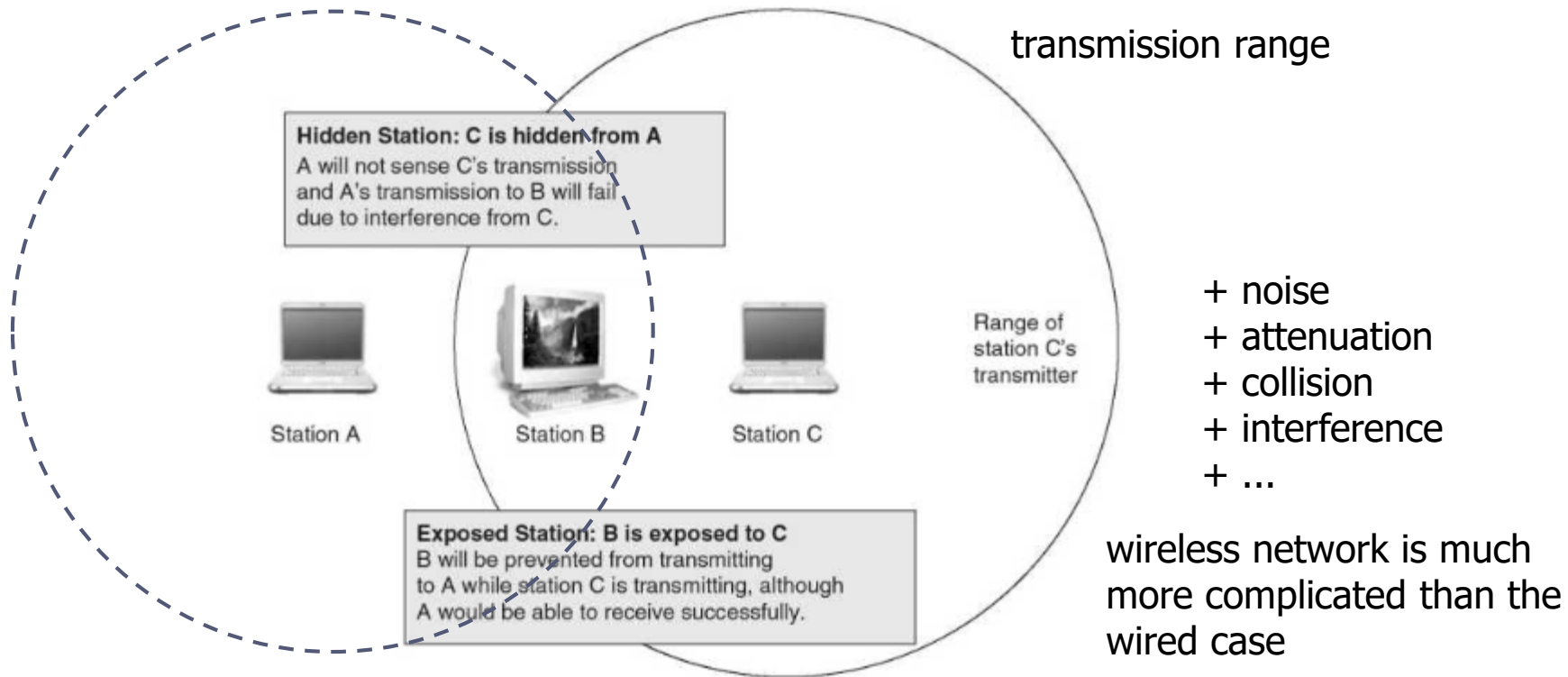

Figure 4-2: Hidden and Exposed Station Challenges for Wireless Media Access Control



Chapter 4

Radio Communication Basics



Spread Spectrum Transmission

Spread Spectrum (used in WiFi and 3G)

- ▶ bandwidth spreading and de-spreading

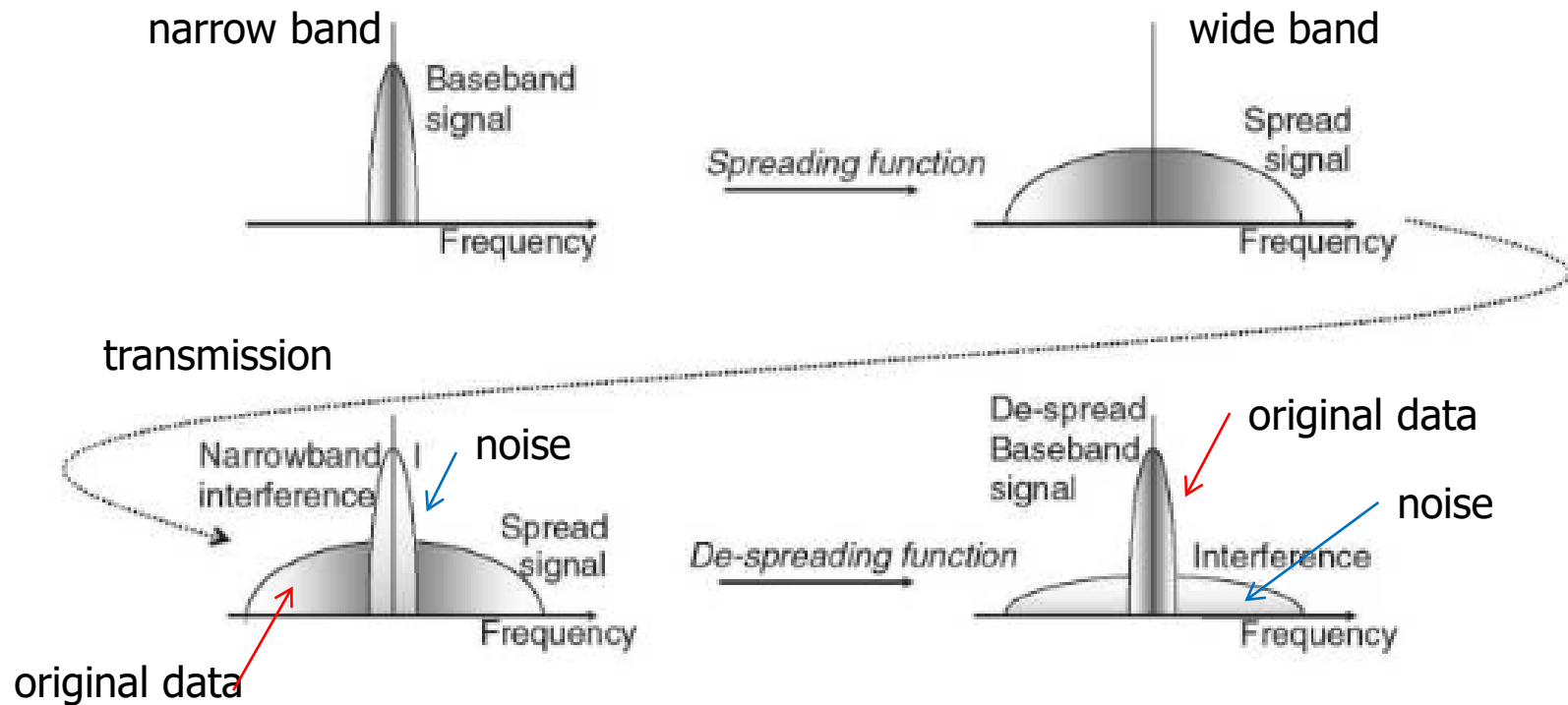

Figure 4-3: A Simple Explanation of Spread Spectrum

- ▶ CDMA: Code Division Multiple Access

DSSS

- ▶ spreading by (pseudo) orthogonal code

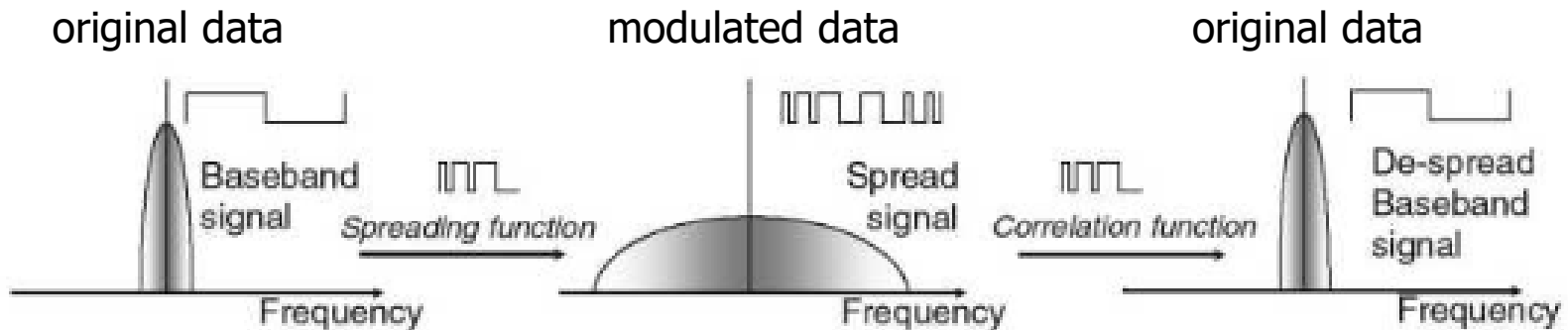

Figure 4-4: A Simple Explanation of DSSS

spreading pattern = "code"

one unique code for one user → CDMA

used in IEEE 802.11b

- ▶ DSSS: Direct Sequence Spread Spectrum

FHSS

- ▶ spreading by frequency hopping pattern

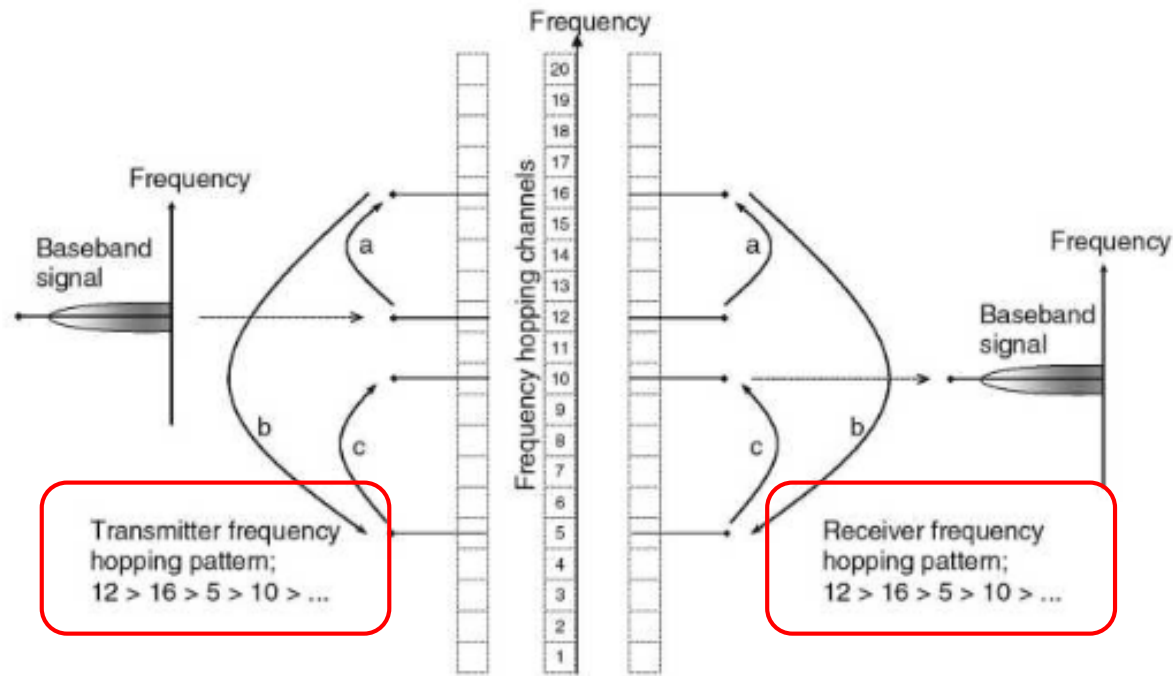

Figure 4-5: A Simple Explanation of FHSS

frequency hopping pattern = "code"

optional in IEEE 802.11b
used in IEEE 802.15.1 (Bluetooth)

- ▶ FHSS: Frequency Hopping Spread Spectrum

THSS

- ▶ spreading by time-slot hopping pattern

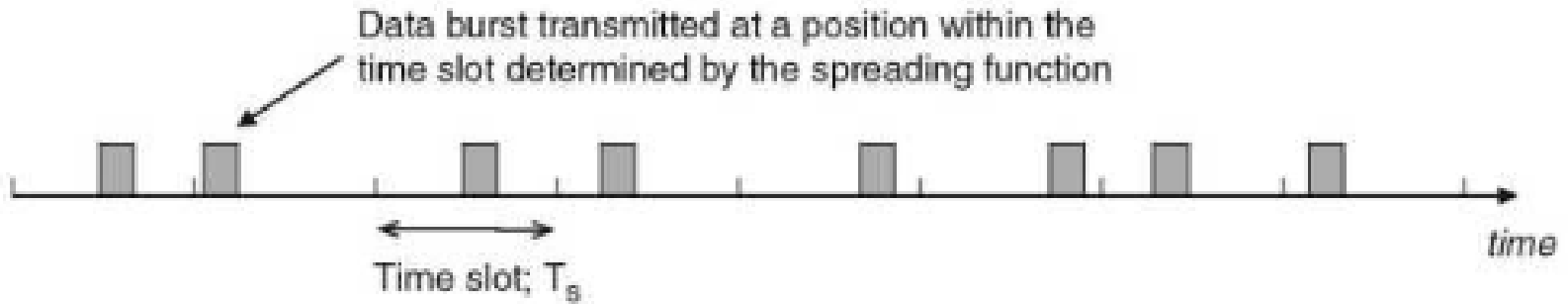

Figure 4-6: A Simple Explanation of THSS

burst position series = "code"

used in UWB (Ultra Wideband)

-
- ▶ THSS: Time Hopping Spread Spectrum

Chirp Spread Spectrum



Linear chirp - frequency sweeping down



Linear chirp - frequency sweeping up



Warble - frequency sweeping up then down



Warble - frequency sweeping down then up

one data → one FM pattern

2 bit data → 4 FM patterns

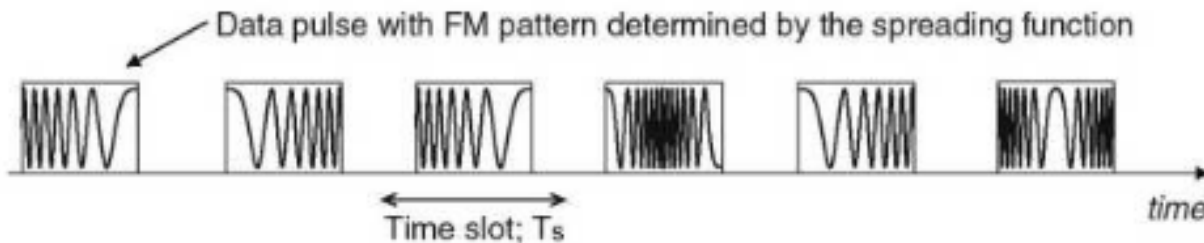

Figure 4-7: A Simple Explanation of Pulsed FM Systems



Barker code (1 and 2 Mbps of IEEE 802.11b)

- ▶ low correlation (i.e. almost orthogonal) between time-shifted codes

Table 4-7: Barker Codes of Length 2 to 13

<i>Length</i>	<i>Code</i>
2	10 and 11
3	110
4	1011 and 1000
5	11101
7	1110010
11	11100010010
13	111100111001

$$0 \times 0 = 1$$

$$0 \times 1 = -1$$

$$1 \times 0 = -1$$

$$1 \times 1 = 1$$

$$0 \rightarrow -1$$

$$1 \rightarrow +1$$



0bit shift → 11

11100010010

01110001001 (1bit shift)

$$-1+1+1-1+1+1-1-1+1-1-1 = -1$$

11100010010

10111000100 (2bit shift)

$$1-1+1-1-1+1-1+1-1-1+1 = -1$$

▶ If "0", completely orthogonal. If small, near orthogonal

DSSS Encoding

- ▶ used in 1 and 2 Mbps of IEEE 802.11b

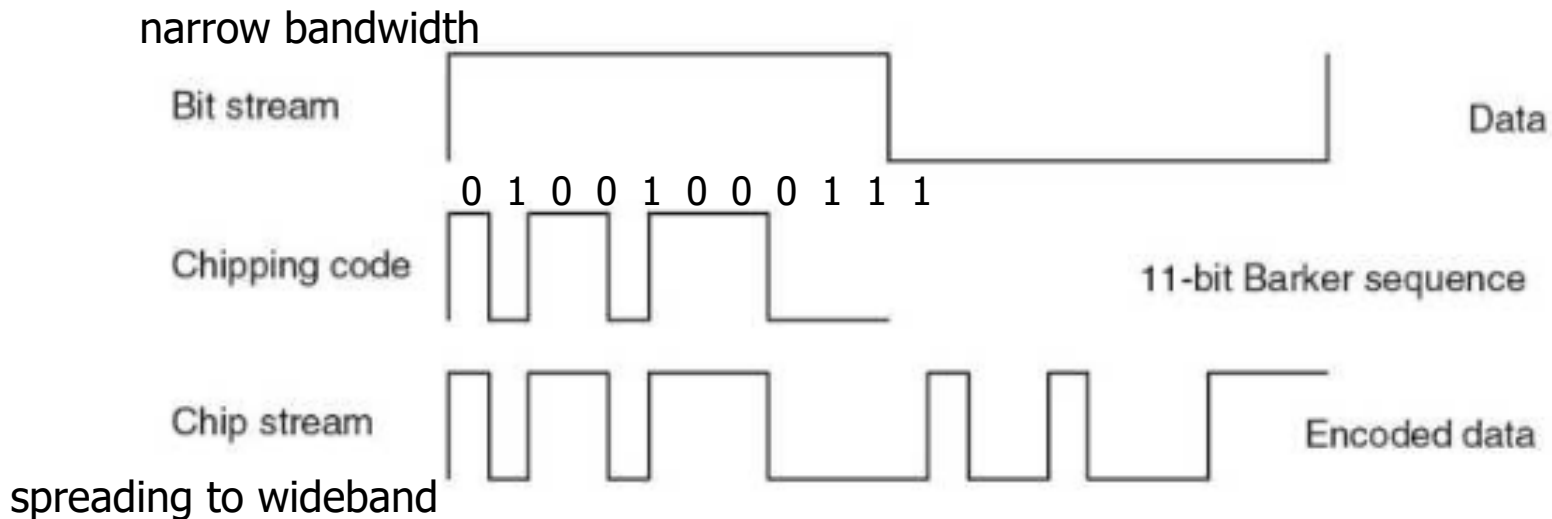

Figure 4-8: DSSS Pseudo-noise Encoding

Decoding:

check all the bit shift and find the most correlated point

synchronization by correlation calculation (by using near-orthogonality of the code)

interference avoidance by low cross correlation

ref. orthogonal codes used in CDMA (Code Division Multiple Access)

Complementary Code Keying (CCK)

- ▶ used in 5.5 and 11Mbps of IEEE 802.11b

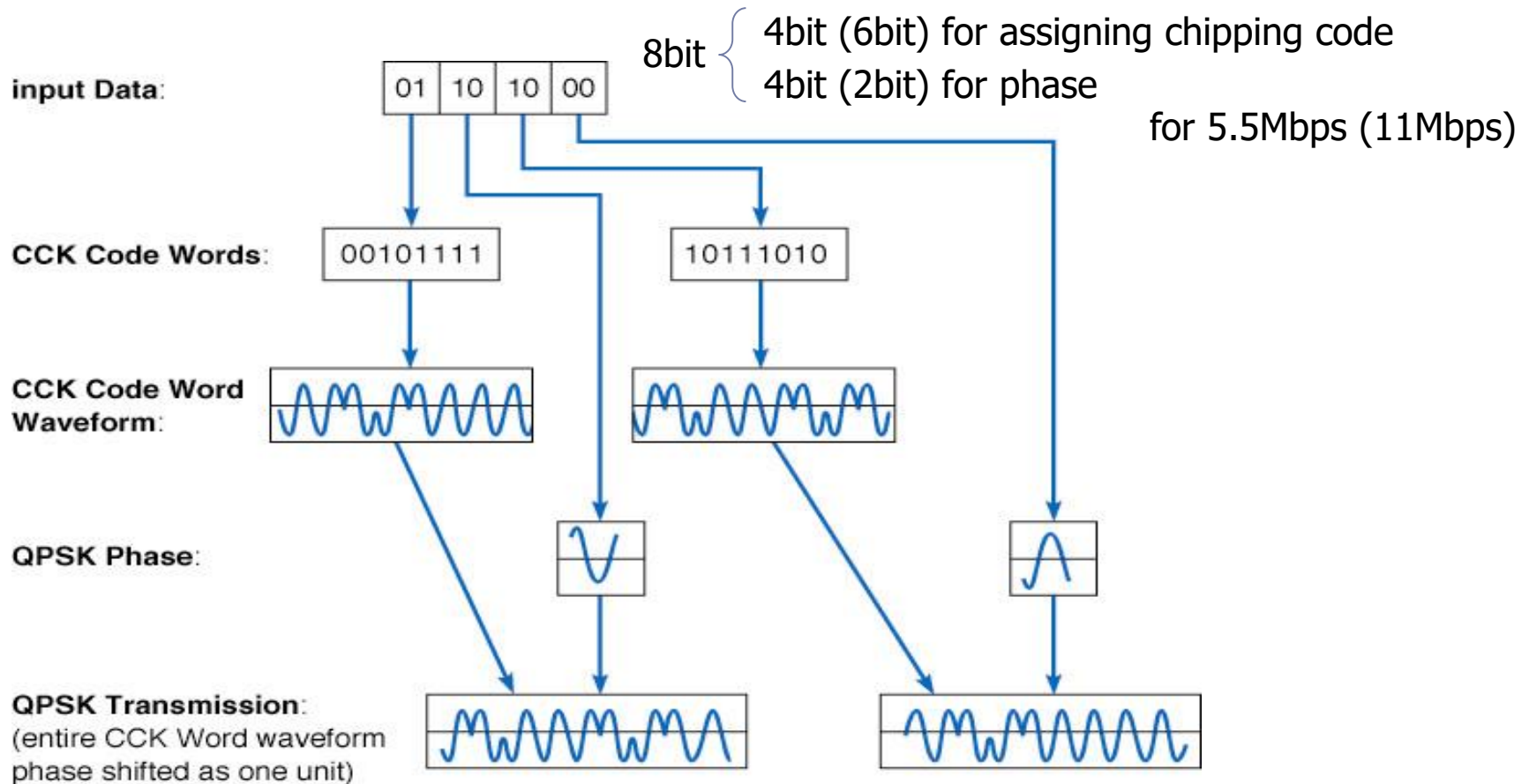

802.11 DSSS Channels in 2.4GHz

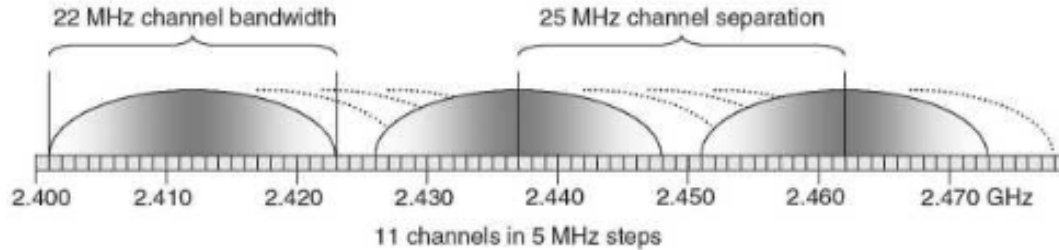

Figure 4-9: 802.11 DSSS Channels

frequency overlap between channels



5ch (25MHz) gap is recommended to avoid interference

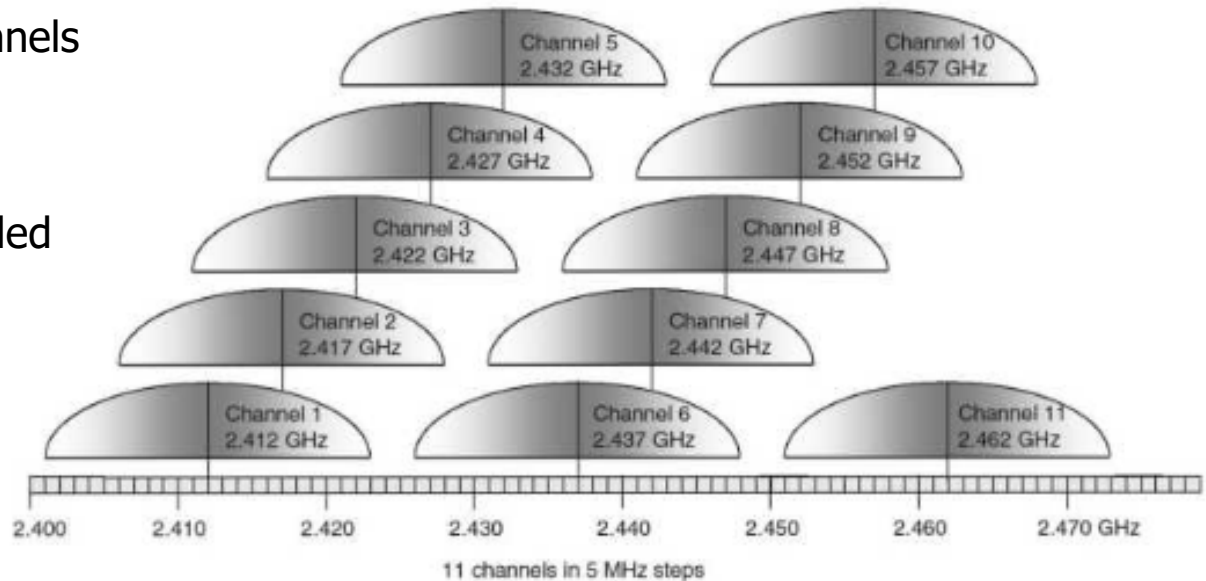

Figure 4-10: DSSS Channels in the 2.4 GHz ISM Band (US)

802.11 FHSS Channels in 2.4GHz

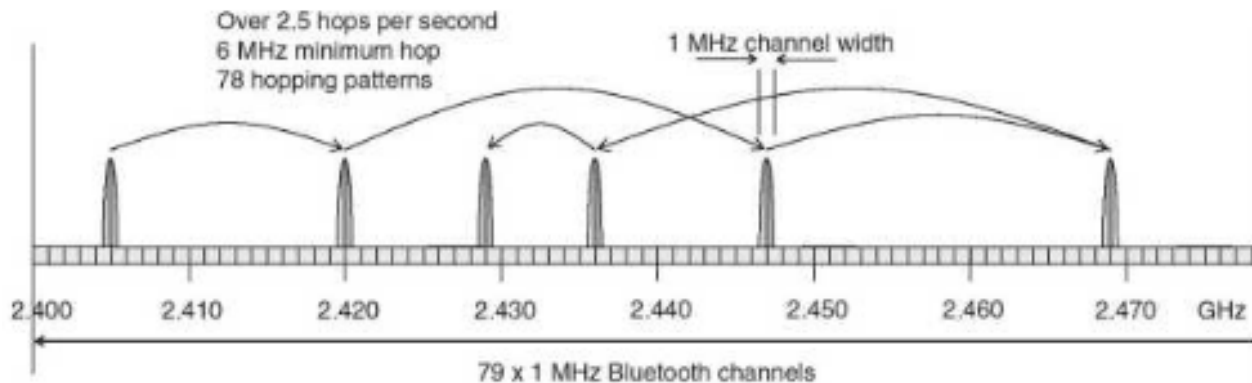

Figure 4-11: FHSS Channels Within the 2.4GHz ISM Band

802.11 THSS Channels in 2.4GHz

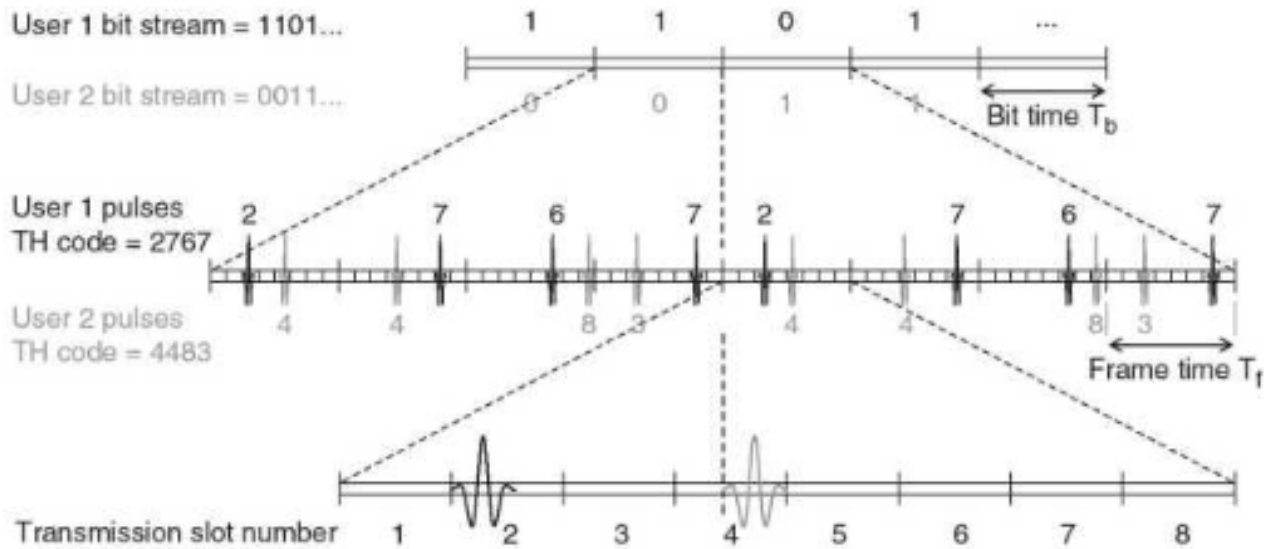

Figure 4-12: Time Hopping Spread Spectrum



Chapter 4

Radio Communication Basics



Wireless Multiplexing and Multiple Access Techniques

TDMA and TDD

- ▶ multiplex in time domain

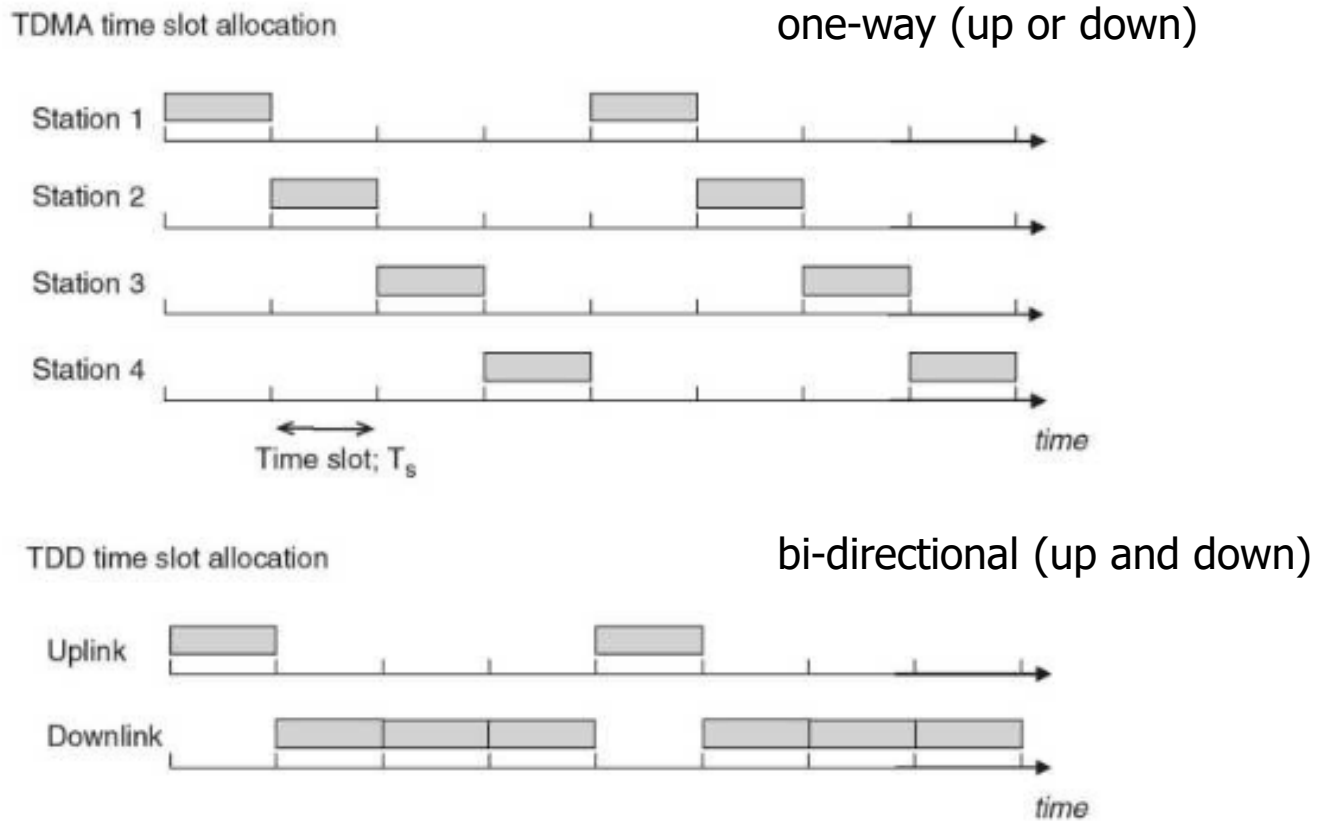

Figure 4-13: Time Division Multiple Access (TDMA) and Duplexing (TDD)

- ▶ used in Bluetooth piconet

FDMA and FDD

- ▶ multiplex in frequency domain

one-way (up or down)

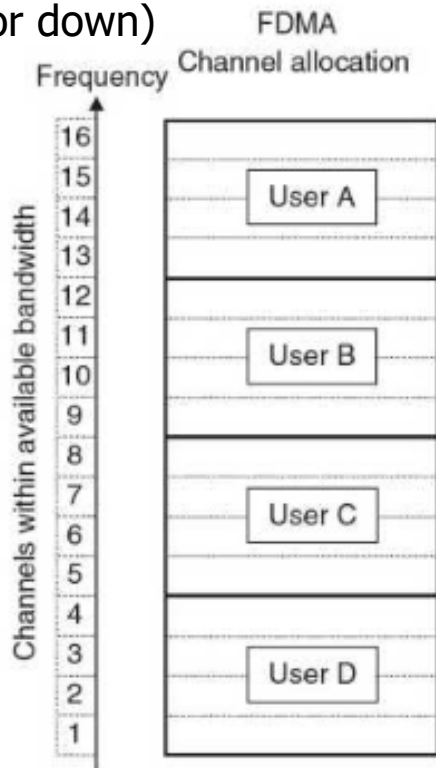

bi-directional (up and down)

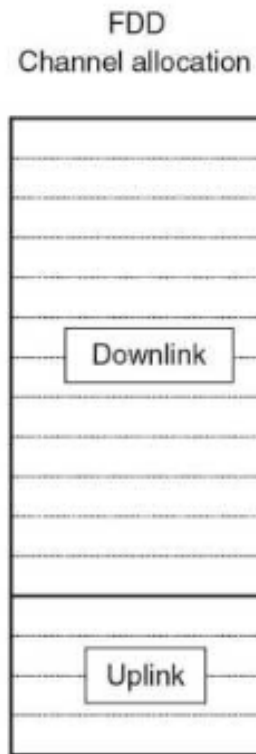

Figure 4-14: Frequency Division Multiple Access (FDMA) and Duplexing (FDD)

- ▶ used in GSM (2G) and UMTS (3G)

FDMA/TDMA Hybrid

- ▶ multiplex in frequency and time domains

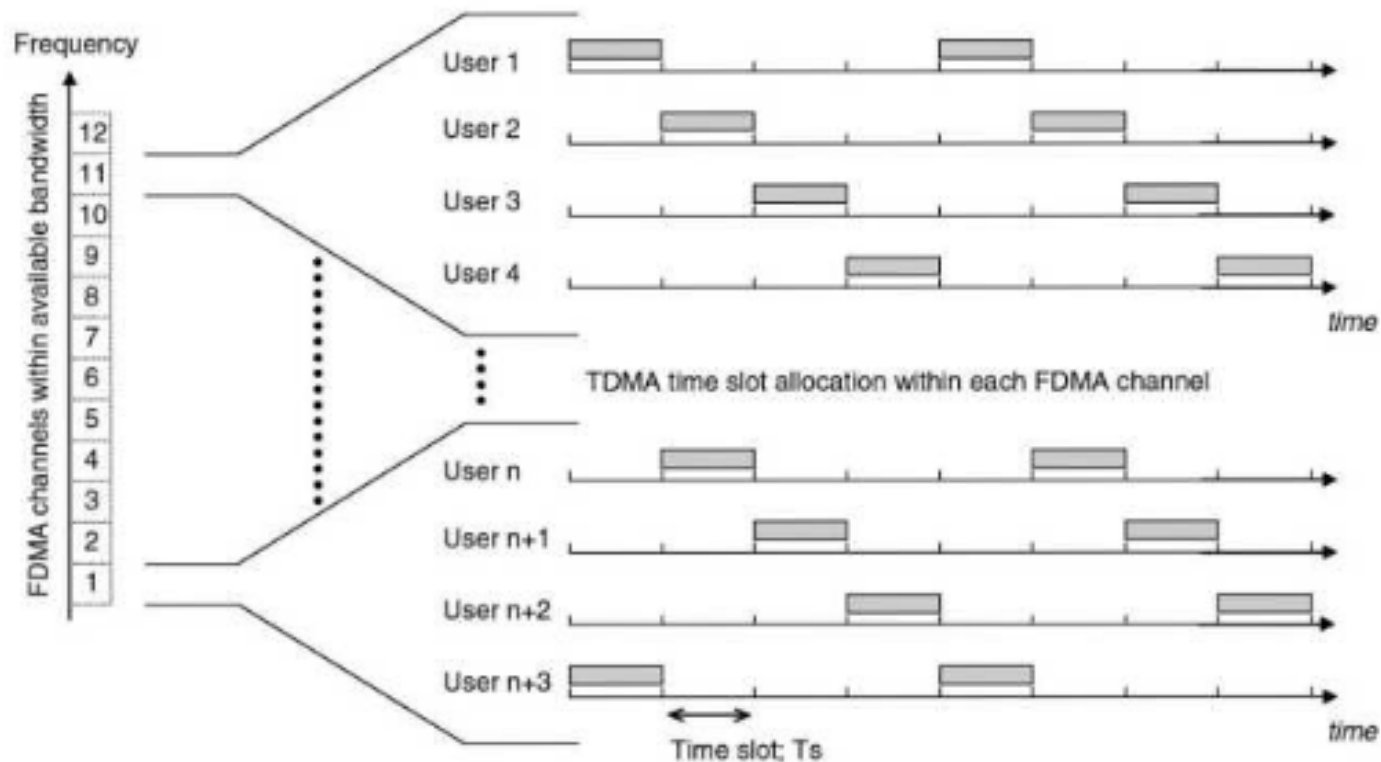

Figure 4-15: FDMA/TDMA Multiple Access System as Used in GSM Cellular Phones

OFDM (1)

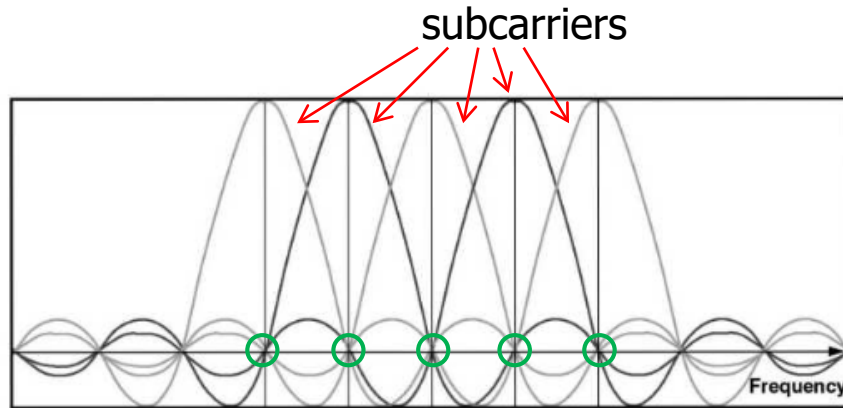

Figure 4-16: Orthogonality of OFDM Subcarriers in the Frequency Domain

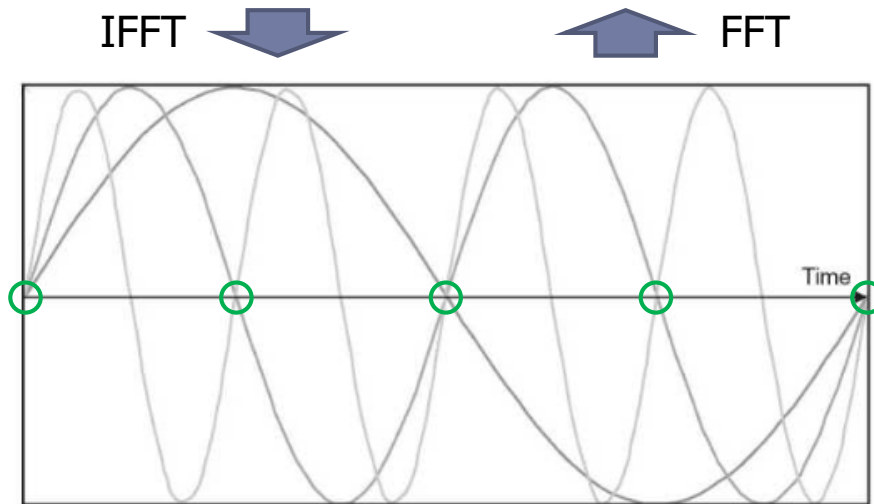

Figure 4-17: Orthogonality of OFDM Subcarriers in the Time Domain

OFDM:
variant of FDM

subcarrier frequencies are chosen to ensure minimum interference between adjacent subcarriers

OFDMA:
use data is conveyed by one or group of subcarrier(s)

combination with CDMA is possible (MC-CDMA)

OFDM (2)

from textbook

- ❑ OFDM can be used as a multiple access technique (OFDMA), by assigning single subcarriers or groups of subcarriers to individual users according to their bandwidth needs.
- ❑ A serial bit stream can be turned into a number of parallel bit streams each one of which is encoded onto a separate subcarrier. All available subcarriers are used by a single user to achieve a high data throughput.
- ❑ A bit stream can be spread using a chipping code and then each chip can be transmitted in parallel on a separate subcarrier. Since the codes can allow multiple user access, this system is known as Multi-Carrier CDMA (MC-CDMA). MC-CDMA is under consideration by the WIGWAM project as one of the building blocks of the 1 Gbps wireless LAN (see the Section “Gigabit Wireless LANs, p. 350”).



OFDM (3)

► Inter Symbol Interference and Guard Interval

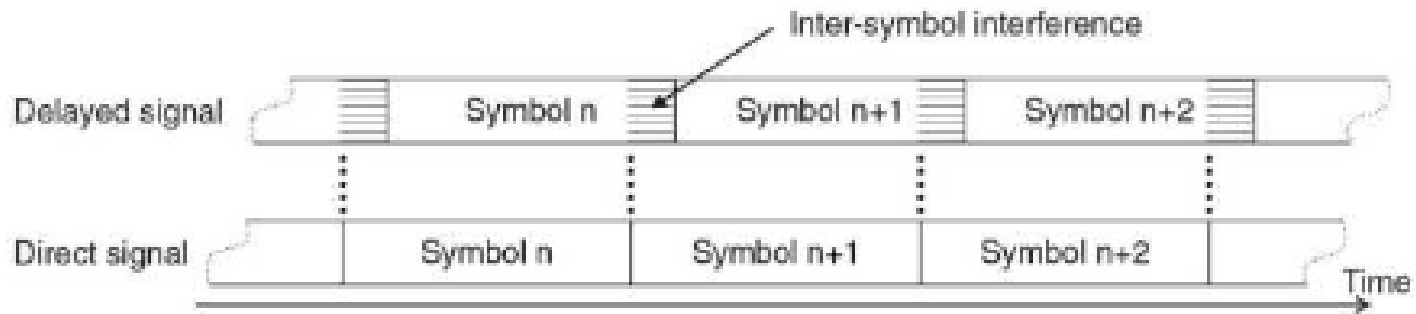

Figure 4-18: Inter Symbol Interference (ISI)



OFDM inserts a Guard Interval between symbols in order to reduce ISI effects caused by multipath fading

OFDM (4)

▶ IFFT/FFT and more

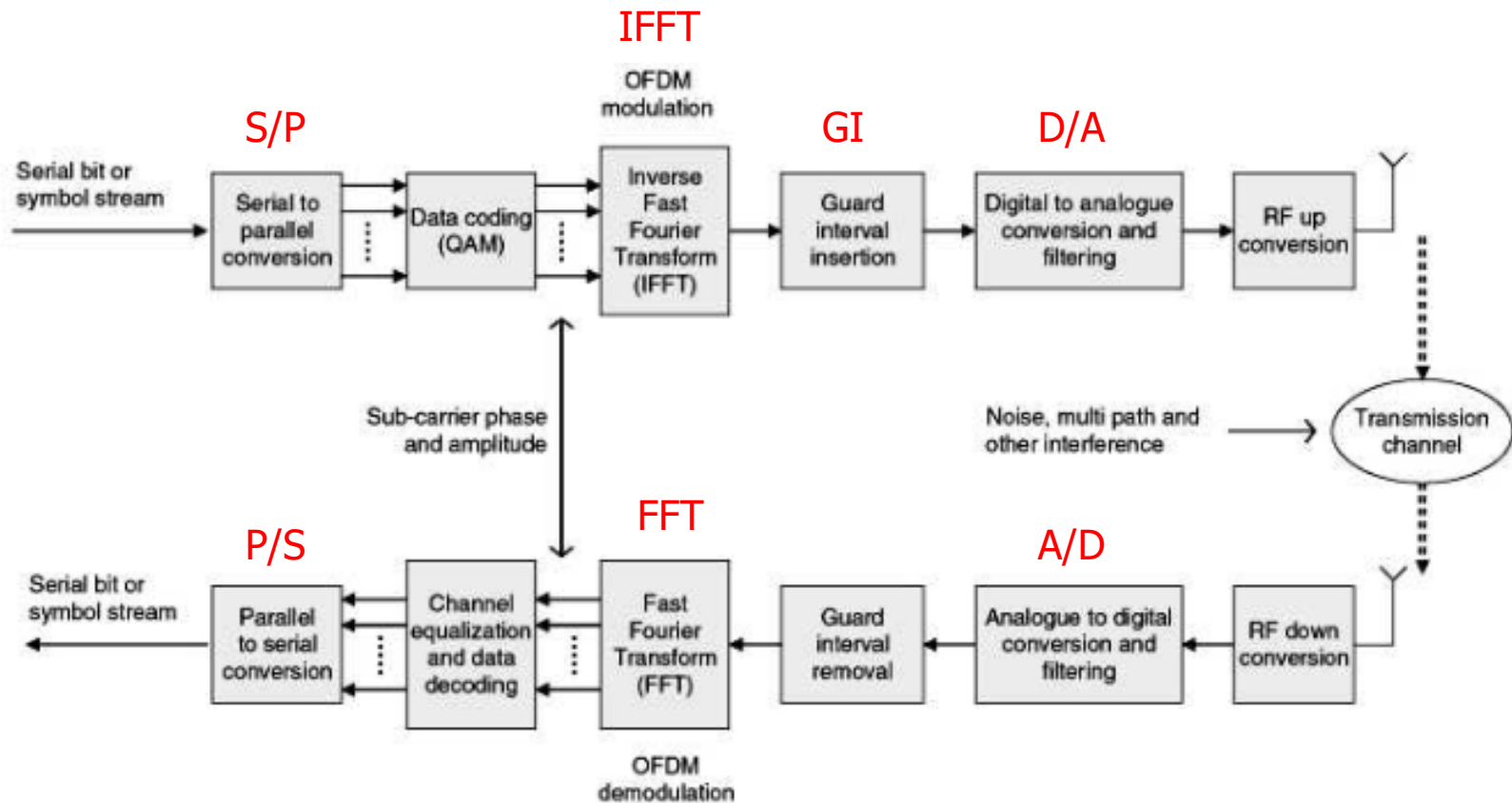
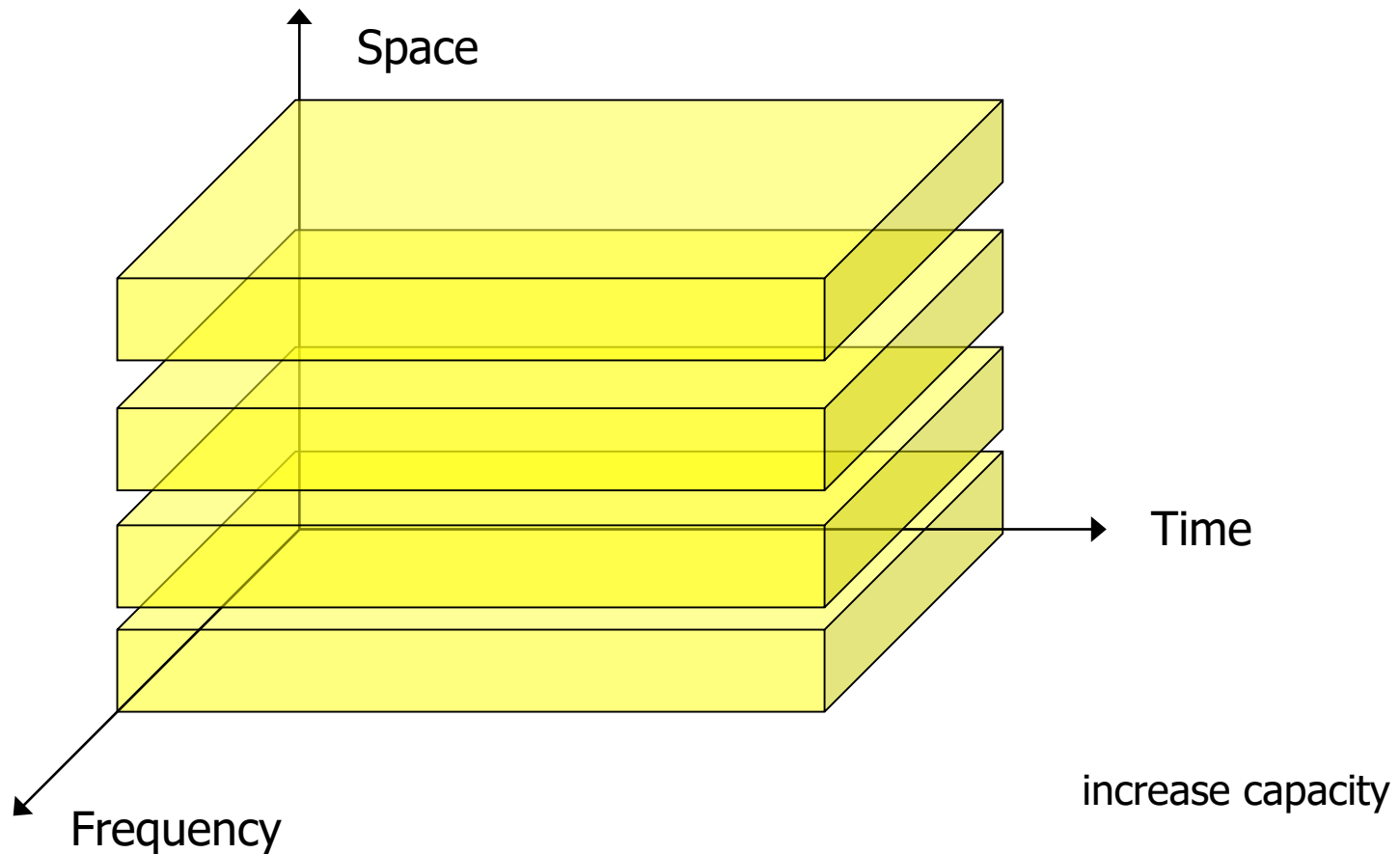

Figure 4-19: Schematic Block Diagram of an OFDM Transmitter and Receiver

▶ used in IEEE 802.11a and 11g

SDMA

- ▶ space division by **smart (directional) antenna**



-
- ▶ SDMA: Space Division Multiple Access

CDMA

▶ Walsh code (orthogonal code)

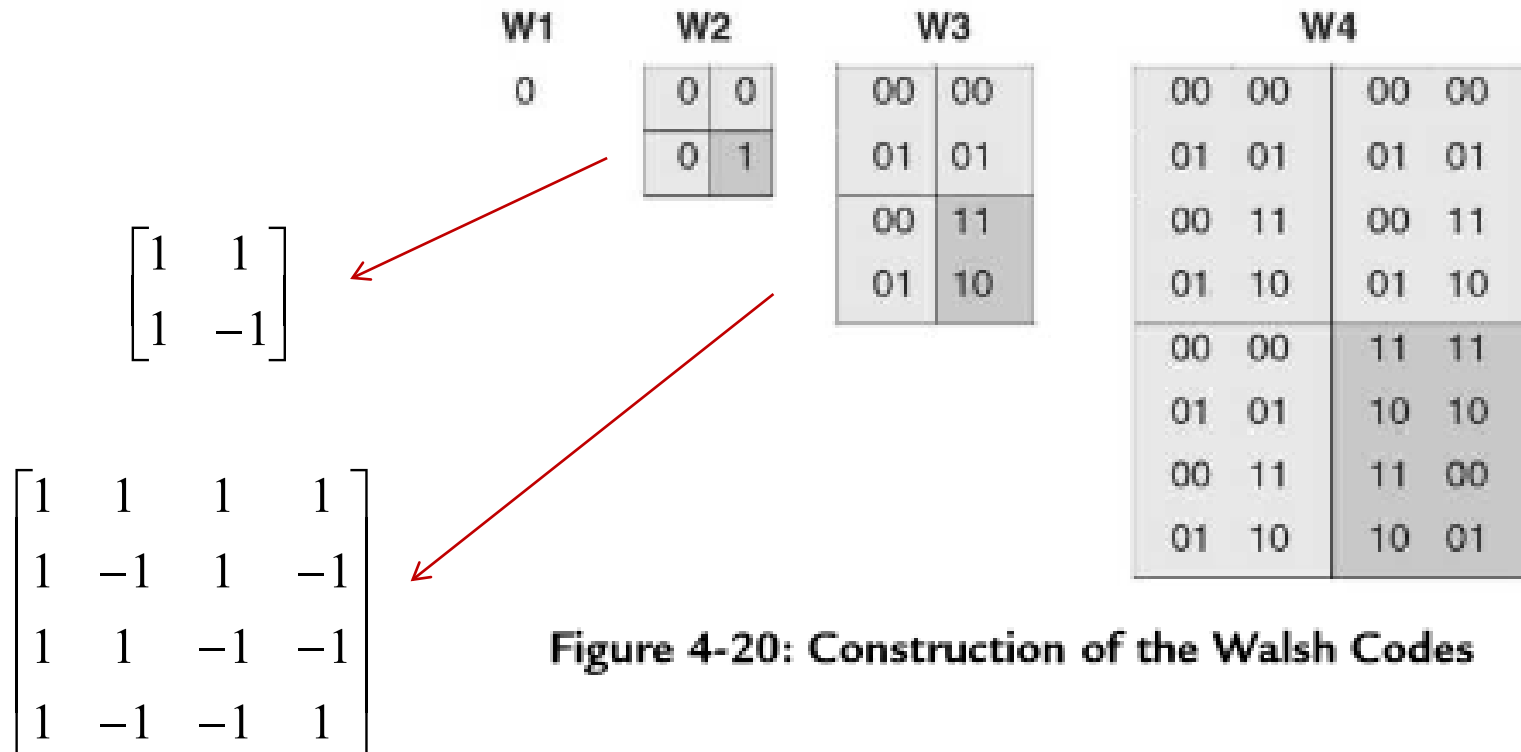

Figure 4-20: Construction of the Walsh Codes

used in 3G telephony system



Chapter 4

Radio Communication Basics



Digital Modulation Techniques

Requirement (from textbook)

- ❑ Spectral efficiency — achieving the desired data rate within the available spectral bandwidth (see Table 4.9).
- ❑ Bit error rate (BER) performance — achieving the required error rate given the specific factors causing performance degradation in the particular application (interference, multipath fading, etc.).
- ❑ Power efficiency — particularly important in mobile applications where battery life is an important user acceptance factor.
- ❑ Modulation schemes with higher spectral efficiency (in terms of data bits per Hz of bandwidth) require higher signal strength for error-free detection.
- ❑ Implementation complexity — which translates directly into the cost of hardware to apply a particular technique. Some aspects of modulation complexity can be implemented in software, which has less impact on end-user costs.

Table 4-9: Spectral Efficiency of Typical Modulation Techniques

<i>Modulation technique</i>	<i>Spectral efficiency (Bits/Hz)</i>
BPSK	0.5
QPSK	1.0
16-QAM	2.0
128-QAM	3.5
256-QAM	4.0

(note) some textbooks say 1.0 bit/Hz for BPSK



Simple Modulations

▶ ON/OFF amplitude shift keying (ASK)

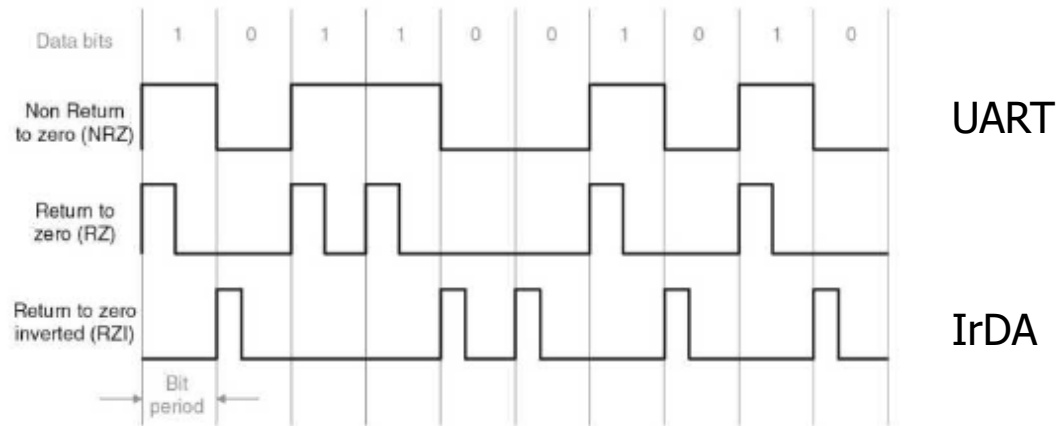

Figure 4-21: NRZ, RZ and RZI Modulation Techniques

UART

IrDA

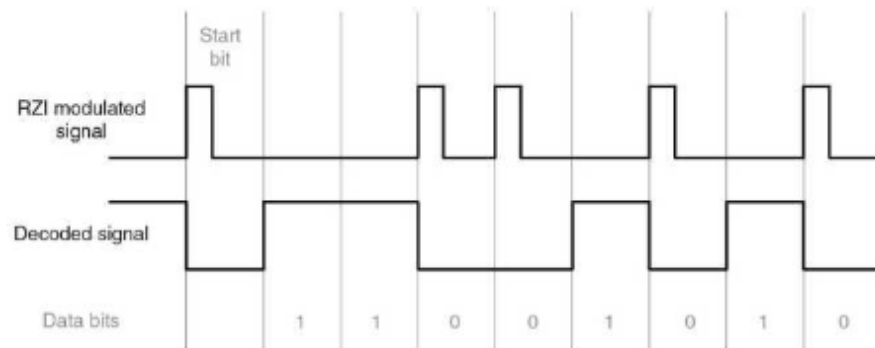

Figure 4-22: RZI Bit Stream Decoding

NRZ, RZ, RZI, ...

UART (Universal Asynchronous Receiver Transmitter)

IrDA (Infrared Data Association)

Phase Shift Keying (1)

- ▶ BPSK: 1 bit, 2 symbols → 2 different phases

Table 4-10: Binary Phase Shift Keying

<i>Symbol</i>	<i>Carrier phase</i>
0	0 degrees
1	180 degrees

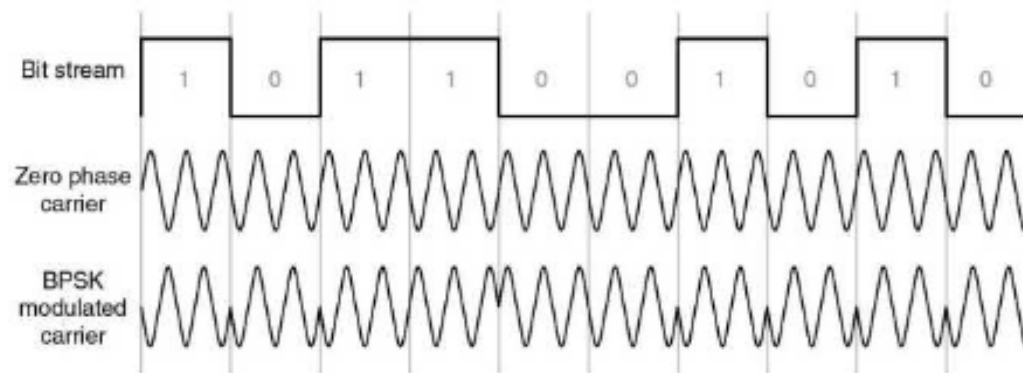

Figure 4-23: Binary Phase Shift Keying Modulation (BPSK)

used in IEEE 802.11b 1Mbps, and IEEE 802.11a 6 and 9 Mbps

- ▶ BPSK: Binary Phase Shift Keying

Phase Shift Keying (2)

- ▶ QPSK: 2 bits, 4 symbols → 4 different phases

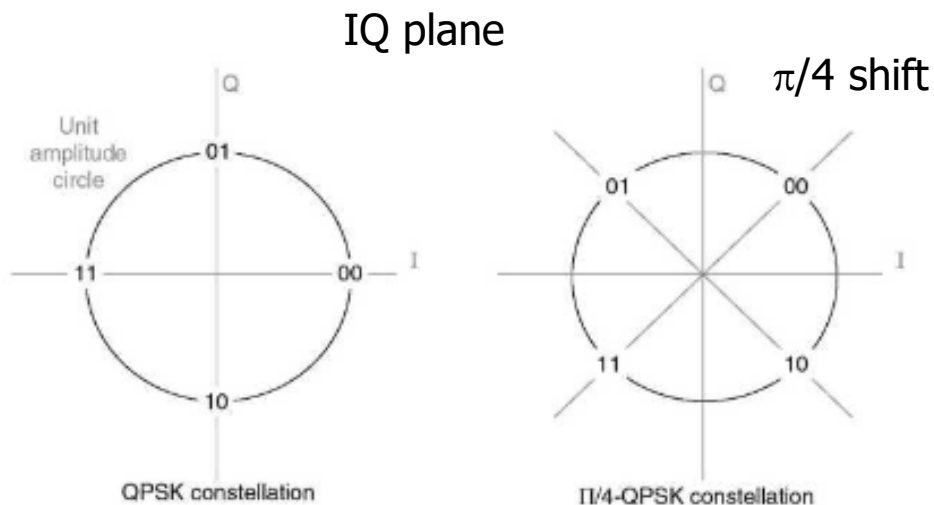

Figure 4-24: QPSK Phase Constellation

Table 4-11: Quadrature Phase Shift Keying

<i>Symbol</i>	<i>Carrier phase</i>
00	0 degrees
01	90 degrees
11	180 degrees
10	270 degrees

used in IEEE 802.11b 2Mbps, and IEEE 802.11a 12 and 18 Mbps

- ▶ QPSK: Quadrature Phase Shift Keying

O-QPSK (offset QPSK)

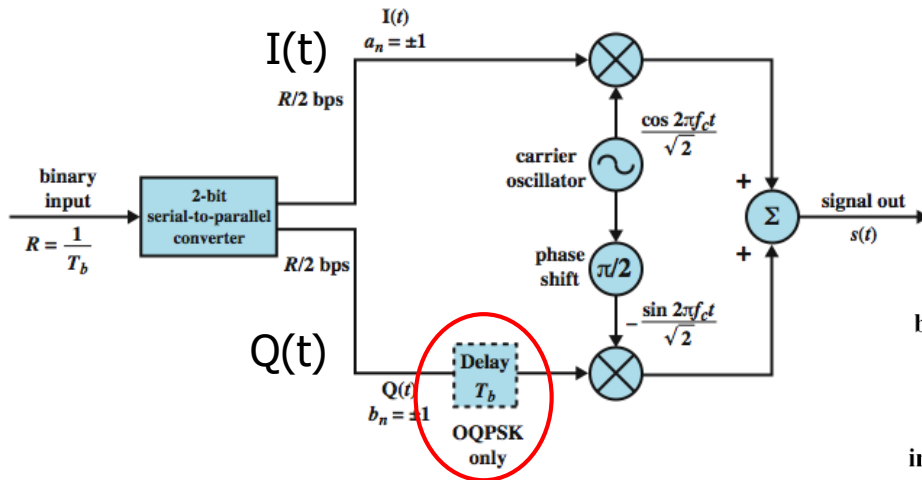

Phase transition of O-QPSK never passes through zero point (i.e. no 180° transition)
 → contribute to narrower spectral width

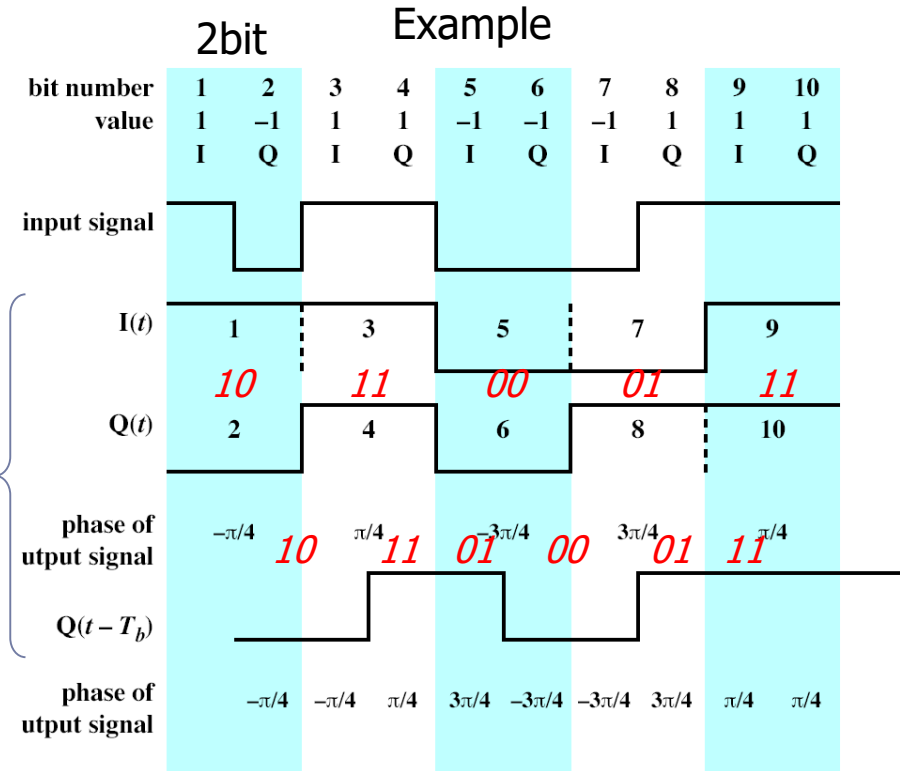
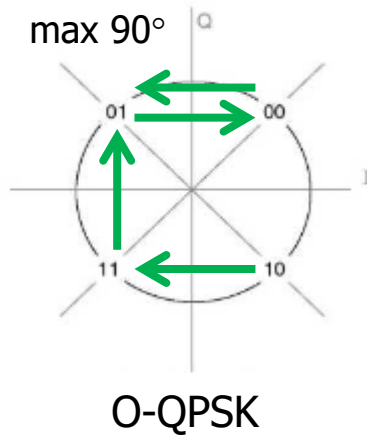
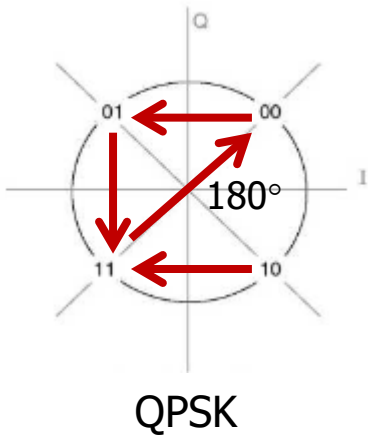

used in IEEE 802.15.4 (ZigBee)

Differential PSK

- ▶ input symbol results in phase change, instead of defining absolute phase

Table 4-12: Differential Quadrature Phase Shift Keying

<i>Symbol</i>	<i>Phase change</i>
00	0 degrees
01	90 degrees
11	180 degrees
10	270 degrees



Table 4-11: Quadrature Phase Shift Keying

<i>Symbol</i>	<i>Carrier phase</i>
00	0 degrees
01	90 degrees
11	180 degrees
10	270 degrees

A receiver only needs to detect relative changes in carrier phase, instead of absolute phase reference

used in Bluetooth



Frequency Shift Keying

- ▶ BFSK (Binary FSK): 2 symbols → 2 different frequencies

Table 4-13: Binary Frequency Shift Keying

<i>Symbol</i>	<i>Carrier frequency</i>
0	$f_0 - f_1$
1	$f_0 + f_1$

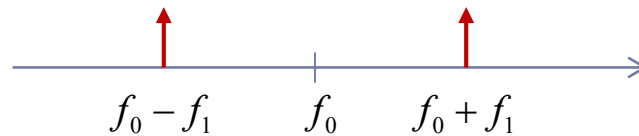

Pre-modulation filter → Gaussian FSK (GFSK)

used in Bluetooth



Quadrature Amplitude Modulation

- ▶ phase modulation + amplitude modulation

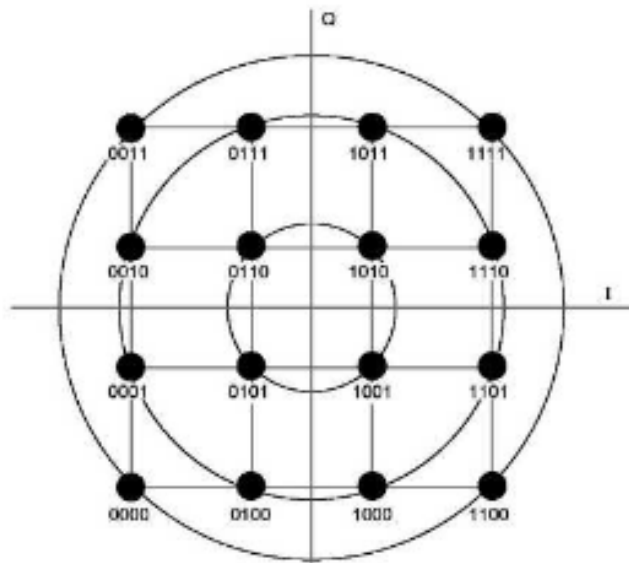

Figure 4-25: 16-QAM Constellation

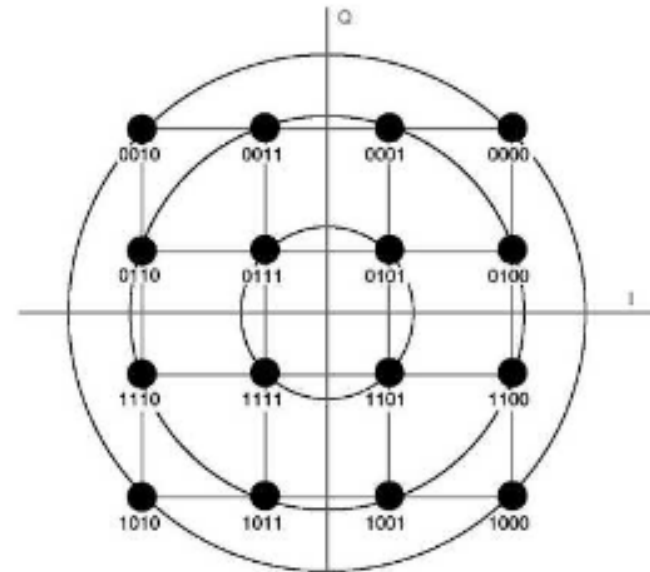

Figure 4-26: Gray Coded 16-QAM Constellation

16 symbols (4bit) → 16 points in IQ plane

Gray code: adjacent points differ only in one bit
→ reduces two bit errors in the receiver

16 QAM and 64 QAM are used in IEEE 802.11 a and g for 24 to 54Mbps

- ▶ QAM: Quadrature Amplitude Modulation

Pulse Modulations (1)

- ▶ PPM: pulse "position" modulation

Table 4-14: Data Symbols for 4-PPM Modulation

<i>Input data symbol</i>	<i>4-PPM data symbol</i>
00	1000
01	0100
10	0010
11	0001

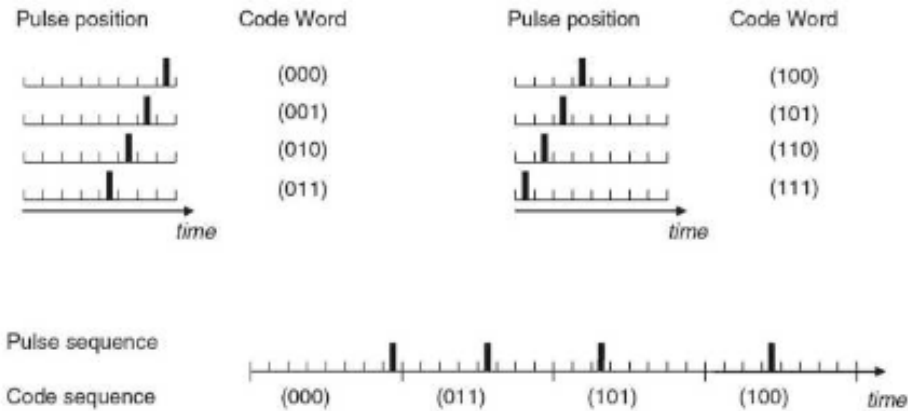

Figure 4-27: 8-PPM Modulation

used in IrDA

Pulse Modulations (2)

- ▶ PSM: pulse “shape” modulation
 - ▶ PAM: pulse “amplitude” modulation
 - ▶ PWM: pulse “width” modulation

Table 4-15: PAM Encoding Table

<i>Input data symbol</i>	<i>Pulse amplitude</i>
00	0
01	1
10	2
11	3

