



# Chapter 4

## Radio Communication Basics



# Chapter 4

## Radio Communication Basics



RF Signal Propagation and Reception

# Basics and Keywords

## ▶ Transmitter Power and Receiver Sensitivity

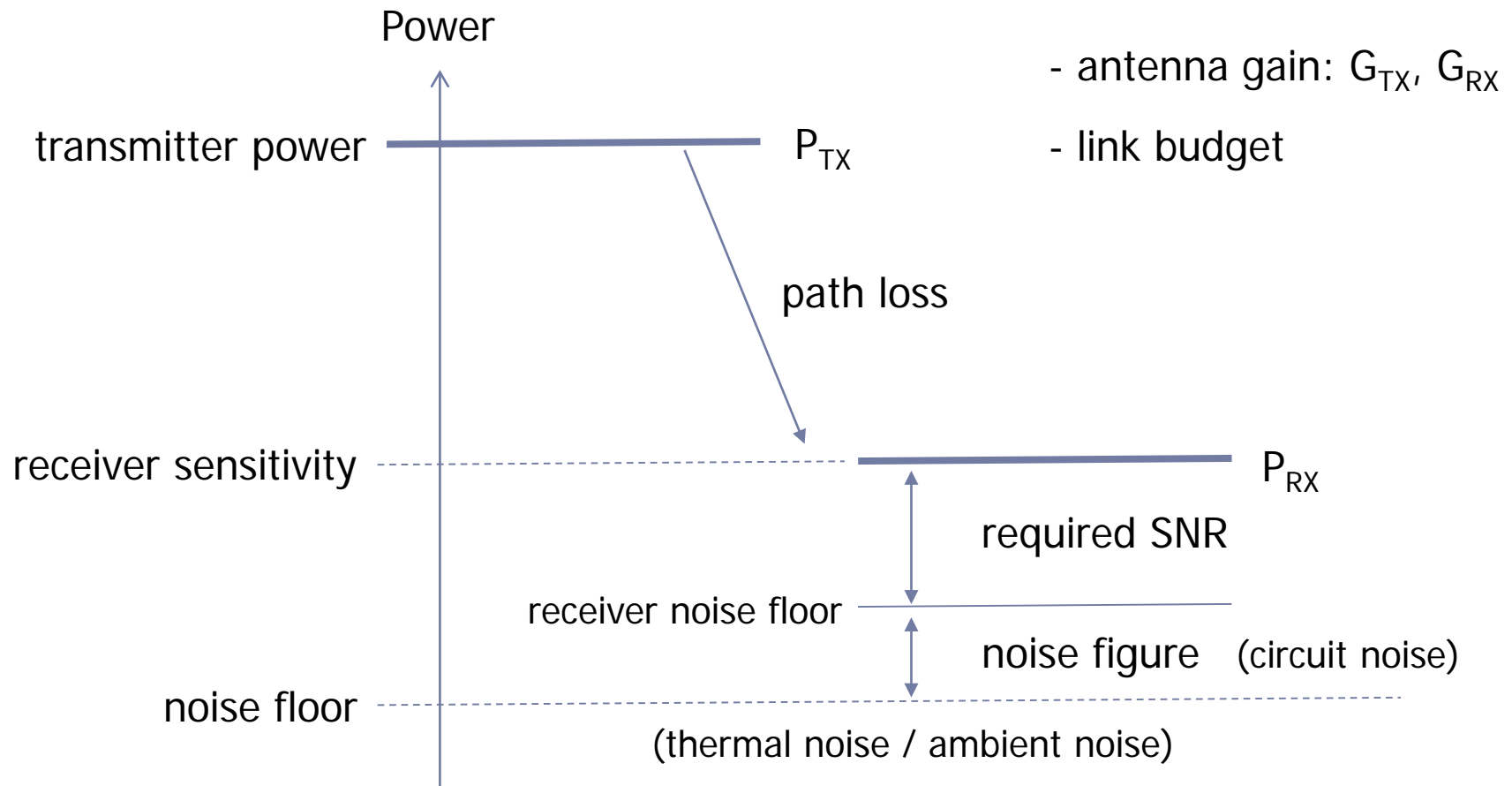

# Transmitter Power

---

- ▶ Transmitter Power ( $P_{TX}$ )

- ▶ Watt and dBm

dBm: power relative to 1 mW

**Table 4-16: Power in mW and dBm**

<i>Power (mW)</i>	<i>Power (dBm)</i>
0.01	-20
0.1	-10
0.5	-3
1	0
10	10
20	13
100	20
1000	30

$$\text{dBm} = 10 \cdot \log_{10}(\text{Power in mW})$$



# Antenna Gain

- ▶ dBi,  $G_{TX}$ ,  $G_{RX}$

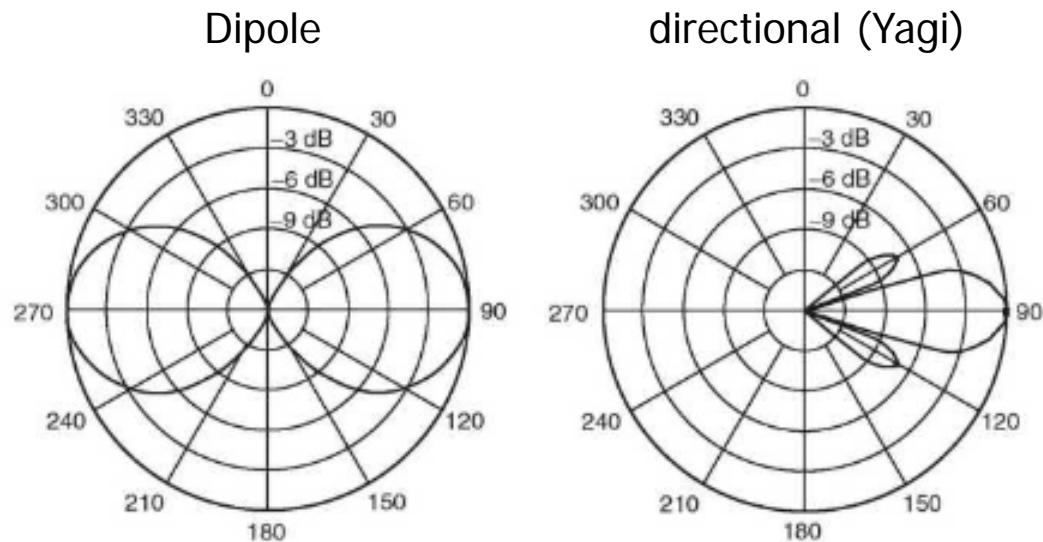

Figure 4-28: Radiation Pattern from Dipole and Yagi Antennas

dBi: antenna gain compared with the hypothetical “isotropic” antenna

$G_{TX}$ : transmitter antenna gain [dB]

$G_{RX}$ : receiver antenna gain [dB]

# Antenna Gain (cont.)

---

▶ Chap.3, p.56

**Table 3-5: Typical Wireless LAN Antenna Parameters for 2.4 GHz Operation**

<i>Antenna type</i>	<i>Sub-type</i>	<i>Beamwidth (Degrees)</i>	<i>Gain (dBi)</i>
Omnidirectional		360	0–15
Patch / Panel		15–75	8–20
Sector		180	8–15
		120	9–20
		90	9–20
		60	10–17
Directional	Yagi	10–30	8–20
	Parabolic reflector	5–25	14–30



# Receiver Sensitivity

---

- ▶ SNR (Signal to Noise Ratio) and BER (Bit Error Rate)

$$SNR = (E_b / N_0) * (f_b / W) \quad (\text{Watt} = \text{Joules/s}, \text{Hz} = 1/\text{s})$$

$E_b$ : energy per bit (Joules/bit)

$N_0$ : noise power density per Hz (Watt/Hz)

$f_b$ : channel data rate (bit/s)

$W$ : channel bandwidth (Hz)

} SNR per bit

} depending on modulation

$$BER = \frac{1}{2} \operatorname{erfc}(\sqrt{SNR}) \quad (\text{from Information Theory})$$



# Receiver Sensitivity (cont.)

## ► BER Characteristics

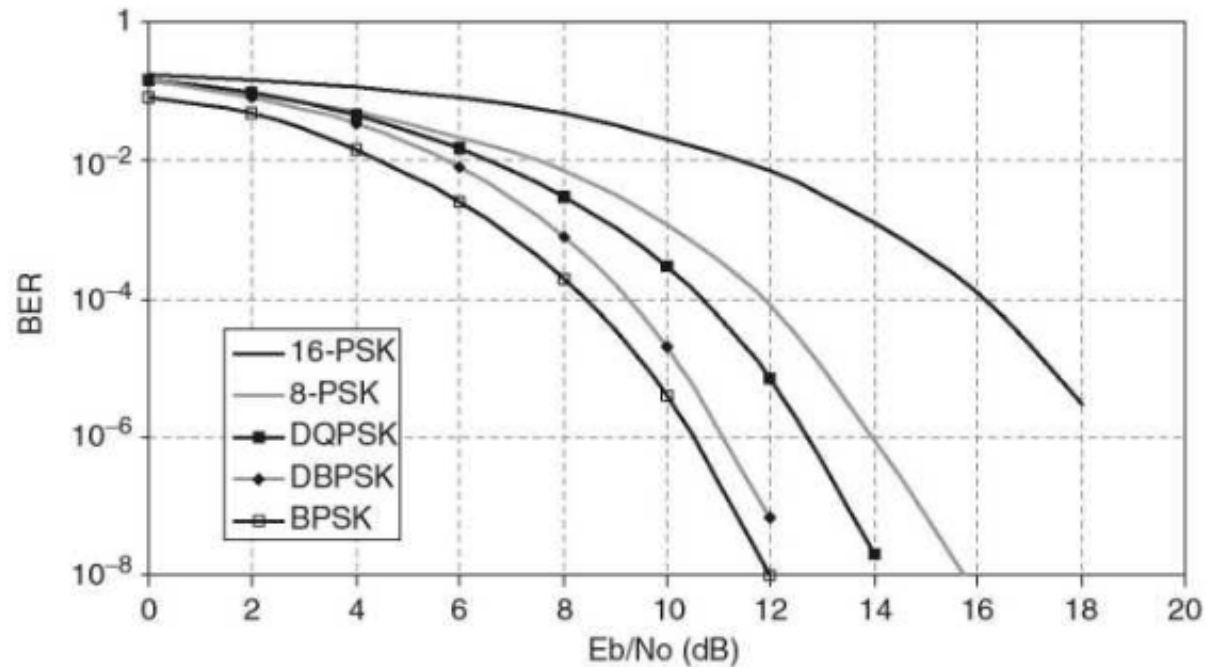

Figure 4-29: Bit Error Rate (BER) for Some Common Modulation Methods



# Receiver Sensitivity (cont.)

## ▶ MATLAB code for $E_b/N_0$ -BER Characteristics

```
clear all;  
SNR = [0:18];  
snr = 10.^(SNR/10);  
ber1 = 1/2 * erfc(sqrt(snr));  
ber2 = 1/log2(4) * erfc(sqrt(log2(4)*snr) * sin(pi/4) );  
ber3 = 1/log2(8) * erfc(sqrt(log2(8)*snr) * sin(pi/8) );  
ber4 = 1/log2(16) * erfc(sqrt(log2(16)*snr) * sin(pi/16) );  
plot(SNR,log10(ber1),'o-',SNR,log10(ber2),'*-',SNR,log10(ber3),'s-',SNR,log10(ber4),'d-');  
legend('BPSK', 'QPSK', '8PSK', '16PSK');  
xlim([0 18]); ylim([-8 0]);  
xlabel('Eb/No (dB)'); ylabel('BER (dB)');
```



theoretical BERs  
for M-PSKs

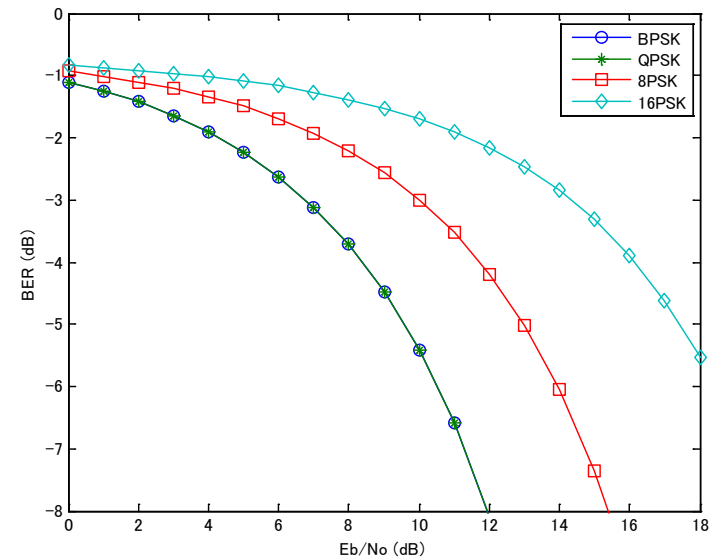

# Receiver Sensitivity (cont.)

---

- ▶ Receiver Noise Floor (RNF)
  - ▶ thermal noise floor (N)
  - ▶ receiver noise figure (NF)

$$N = kTW$$

thermal noise

k: Boltzmann constant  
T: temperature in K°  
W: bandwidth (Hz)

$$NF : 6 \text{ to } 15 \text{ dB}$$

noise due to amplifier etc.



$$RNF = N + NF$$

~ -100dBm



# Receiver Sensitivity (cont.)

---

- ▶ Receiver Sensitivity ( $P_{RX}$ )
  - ▶ power required to achieve desired BER

$$P_{RX} = RNF + SNR$$

**Table 4-17:  $P_{RX}$  Versus Data Rate for a Typically 802.11b Receiver**

<i>Data Rate (Mbps)</i>	<i>Modulation technique</i>	<i><math>P_{RX}</math> (dBm)</i>
11	256 CCK + DQPSK	-85
5.5	16 CCK + DQPSK	-88
2	Barker + DQPSK	-89
1	Barker + DBPSK	-92



# Receiver Sensitivity (cont.)

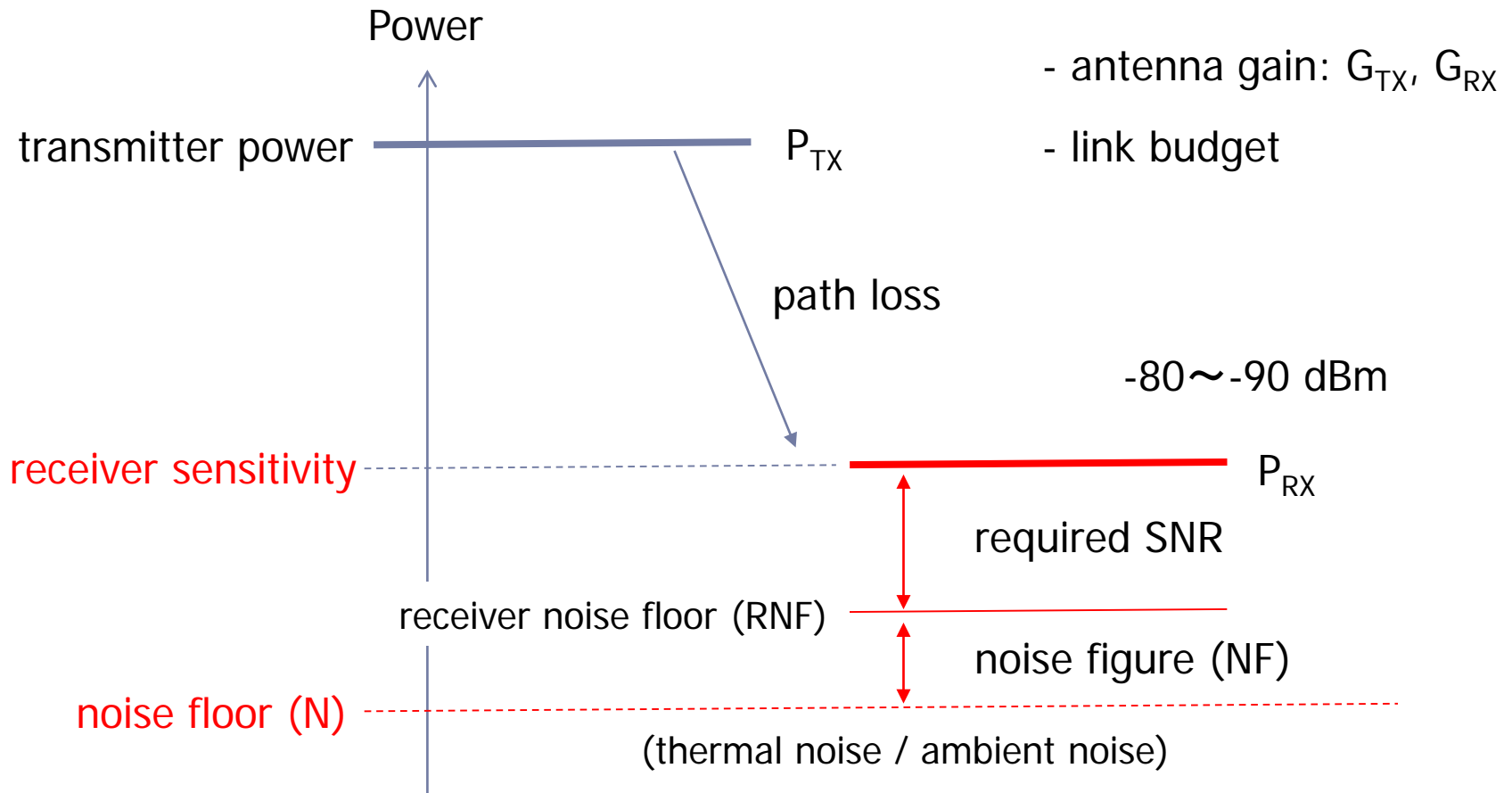

# RF Signal Propagation and Losses

---

## ▶ Free Space Loss ( $L_{FS}$ )

$$L_{FS} = 20 \log_{10} \frac{4\pi D}{\lambda} = 10 \log_{10} \left( \frac{4\pi D}{\lambda} \right)^2$$

D: transmitter to receiver distance [m]

$\lambda$ : wavelength of the radio [m]

$\lambda = c / f$       c: speed of light [m/s]

f: signal frequency [Hz]

radio signal attenuates in proportion to square of the distance, and also does in proportion to square of the frequency

---



# RF Signal Propagation and Losses (cont.)

- ▶ Free space loss of 2.4GHz and 5.8GHz

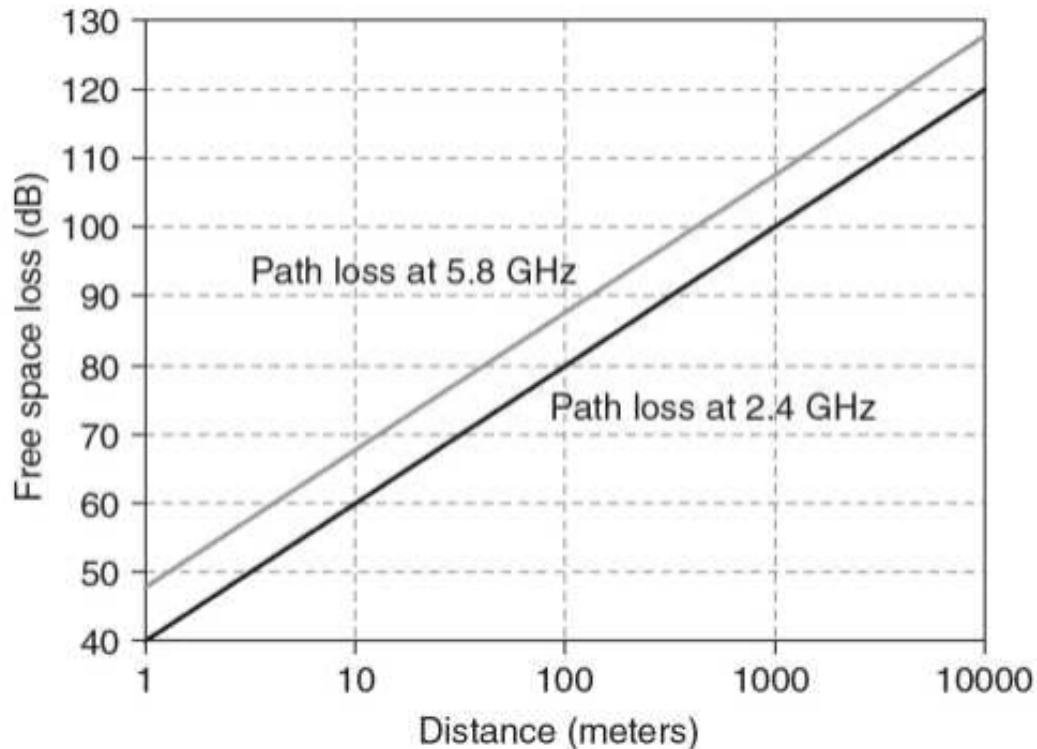
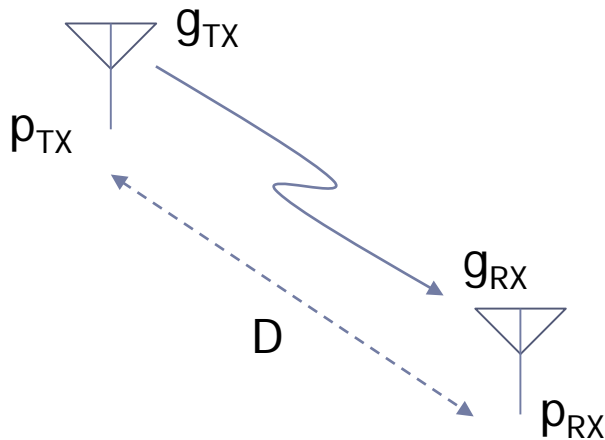

**Figure 4-30: Free Space Loss at 2.4 GHz and 5.8 GHz**

# RF Signal Propagation and Losses (cont.)

## ► Friis's Equation

$$P_{RX} = \left( \frac{\lambda}{4\pi D} \right)^2 g_{TX} g_{RX} P_{TX}$$



D: transmitter to receiver distance [m]

$\lambda$ : wavelength of the radio [m]

$P_{TX}$ : transmitter power [W]

$P_{RX}$ : receiver sensitivity (receiver power) [W]

$g_{TX}$ : transmitter antenna gain

$g_{RX}$ : receiver antenna gain

$$\left. \begin{array}{l} P_{TX} = \log_{10} p_{TX} \quad P_{RX} = \log_{10} p_{RX} \\ G_{TX} = \log_{10} g_{TX} \quad G_{RX} = \log_{10} g_{RX} \end{array} \right\}$$



$$P_{RX} = P_{TX} + G_{TX} + G_{RX} - L_{FS}$$



# RF Signal Propagation and Losses (cont.)

## ► Fresnel Zone

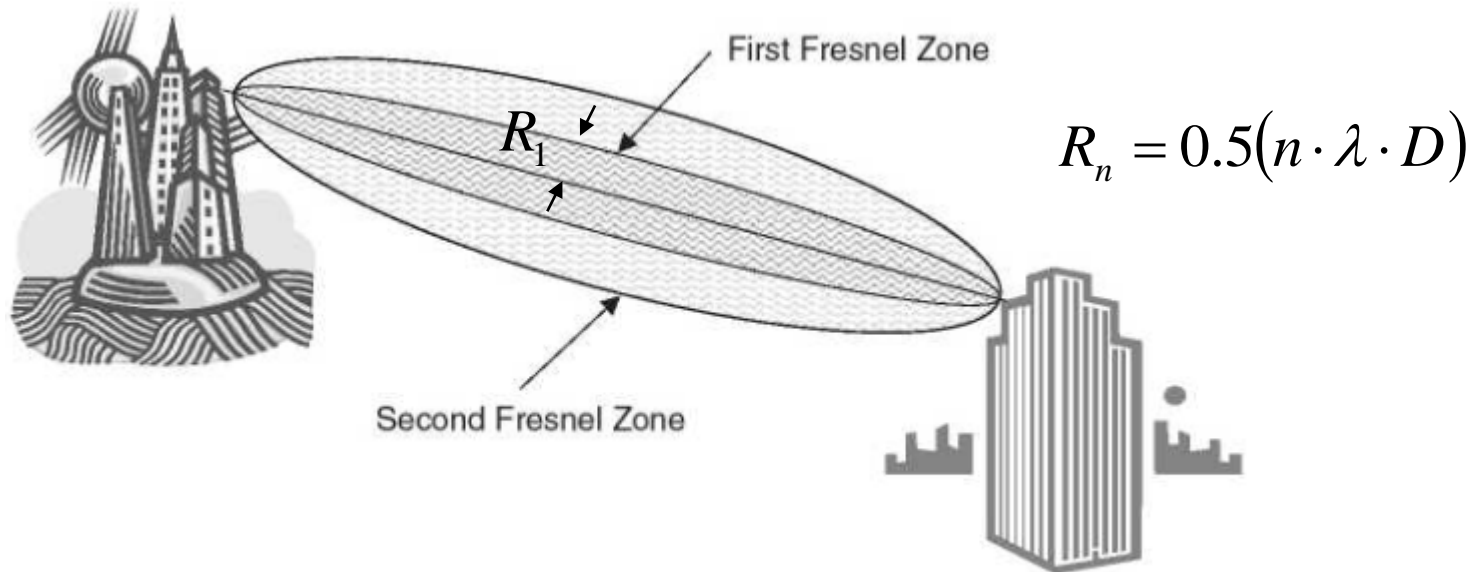

**Figure 4-31: The Fresnel Zones Around a Propagation Path**

If Fresnel zone is ensured, free space loss assumption comes into effect.  
If obstacles exist in the Fresnel zone, heavy losses might happen.



# RF Signal Propagation and Losses (cont.)

---

## ▶ Multipath Fading

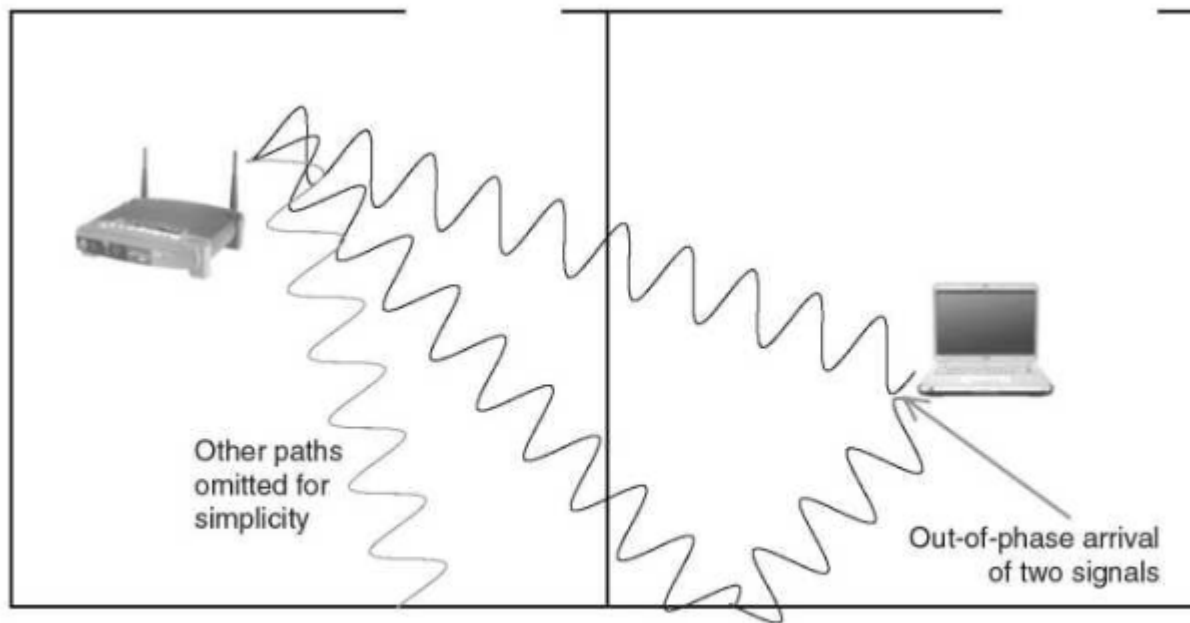

**Figure 4-32: Multi-path Fading in an Indoor Environment**

Signals arriving along different paths cause interference, which can be as much as 20 to 30 dB loss.



# RF Signal Propagation and Losses (cont.)

---

## ▶ Signal Attenuation Indoors

**Table 4-18: Typical Attenuation for Building Materials at 2.4 GHz**

<i>Attenuation range</i>	<i>Materials</i>	<i>Loss (dB)</i>
Low	Non tinted glass, wooden door, cinder block wall, plaster.	2–4
Medium	Brick wall, marble, wire mesh or metal tinted glass.	5–8
High	Concrete wall, paper, ceramic bullet-proof glass.	10–15
Very high	Metal, silvering (mirrors).	>15

Indoor obstructions such as walls, floors, furniture and so on cause 3 to 6 dB or more signal attenuation.

---



# RF Signal Propagation and Losses (cont.)

---

## ▶ Link Budget

- ▶ Friis's equation + fade margin ( $L_{FM}$ )

to compensate multipath fading, obstacle losses, ...

$$P_{TX} = P_{RX} - G_{TX} - G_{RX} + L_{FS} + L_{FM}$$

Transmitter power ( $P_{TX}$ ) required to deliver a signal to a receiver at its sensitivity limit ( $P_{RX}$ )

The signal at the receiving antenna has to be above the receiver sensitivity ( $P_{RX}$ )

e.g.  $P_{TX} = -90\text{dBm} - 14\text{dBi} - 6\text{dBi} + 80\text{dB} + 36\text{dBm} = +6\text{dBm}$   
... 4mW



# RF Signal Propagation and Losses (cont.)

## ▶ Link Budget (cont.)

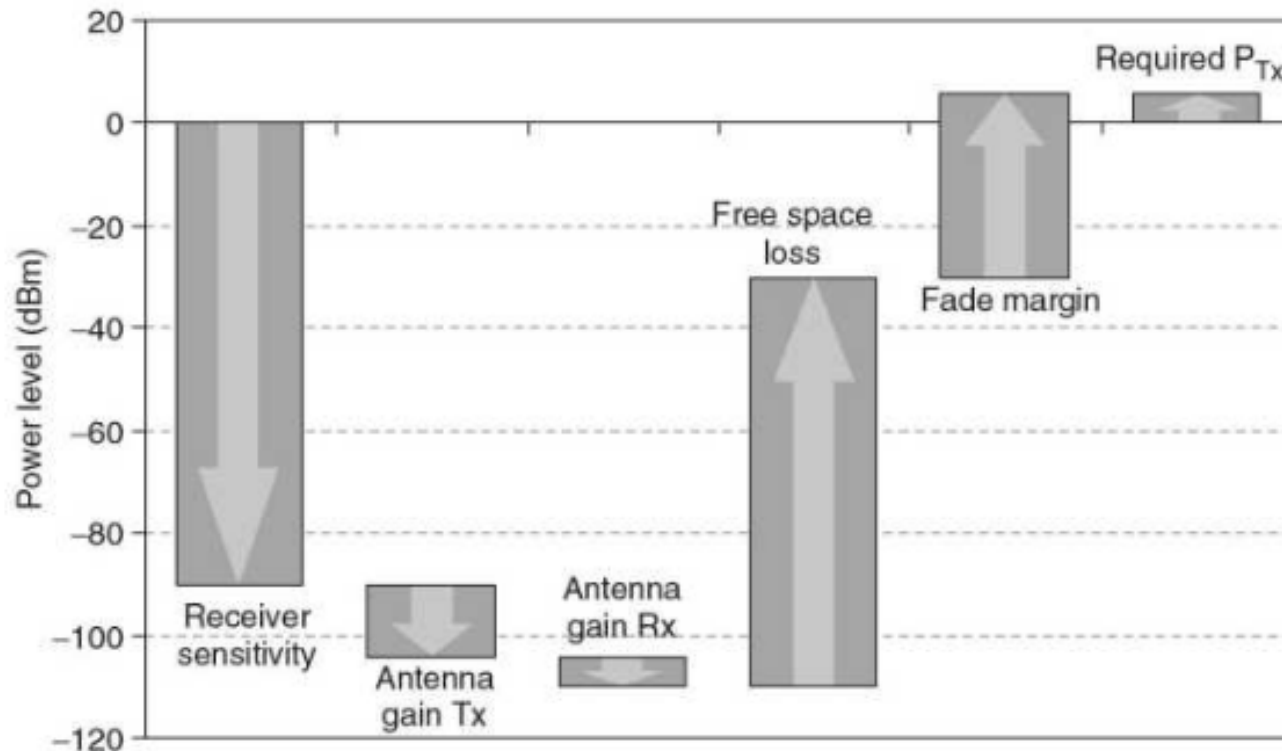
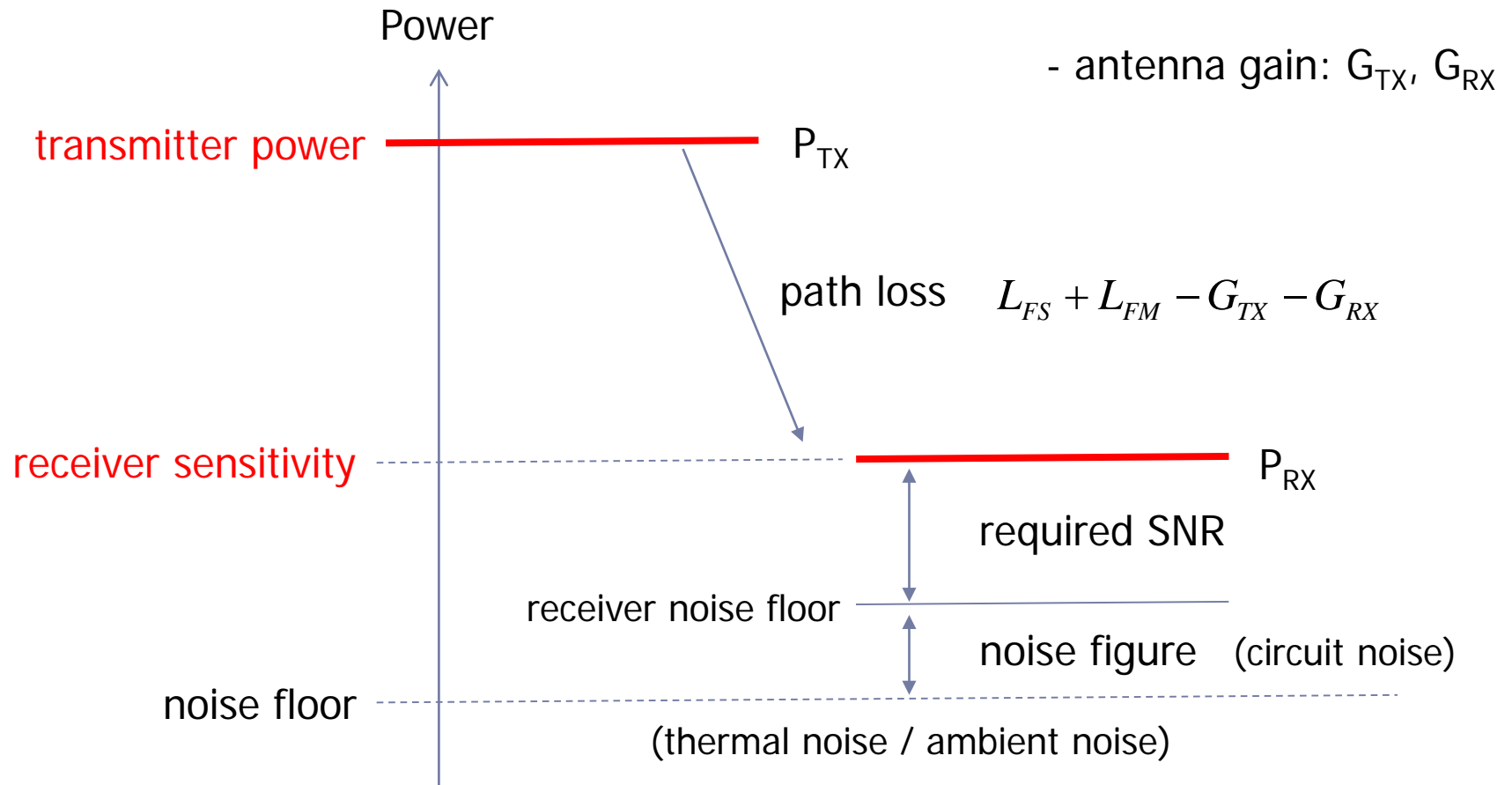

Figure 4-33: Link Budget Expressed as Required Transmitter Power

# RF Signal Propagation and Losses (cont.)

## ▶ Link Budget (cont.)



# RF Signal Propagation and Losses (cont.)

---

## ▶ Ambient Noise

- ▣ Ambient noise floor — the aggregate background noise from distant sources such as car ignition, power distribution and transmission systems, industrial equipment, consumer products, distant electrical storms and cosmic sources.
- ▣ Incidental noise — the aggregate background noise from localised man-made sources.



# RF Signal Propagation and Losses (cont.)

---

## ► Interference Mitigation

**Table 4-20: Wireless USB Interference Mitigation Controls**

<i>Control</i>	<i>Description</i>	
Transmit power (TPC)	Host can control its own transmit power level as well as querying and controlling transmit power of devices in the cluster.	power control
Transmitted bit rate	Host can adjust the transmitted bit rate for both outward (host to device) and inward (device to host) transfers.	modulation control
Data payload size	When interference causes <i>PER</i> to rise, reducing packet size can improve throughput by reducing uncorrectable errors.	packet size control
RF channel selection	Wireless USB's MB-OFDM radio provides multiple alternative channels which can be used by a host if supported by all devices in the cluster.	channel selection
Host schedule control	Allowing isochronous data transfers to temporarily use channel time allocated for asynchronous transfers, in order to retransmit failed isochronous data packets.	
Dynamic bandwidth control	Host control of the spectral shaping capabilities of the MB-OFDM UWB radio, described in the following section.	

---



# Chapter 4

## Radio Communication Basics



Ultra Wideband Radio



# Ultra Wideband Radio

- ▶ Originally for military applications
  - ▶ impulse radio by extremely short pulses less than 1ns, which result in wideband from 500MHz to several GHz

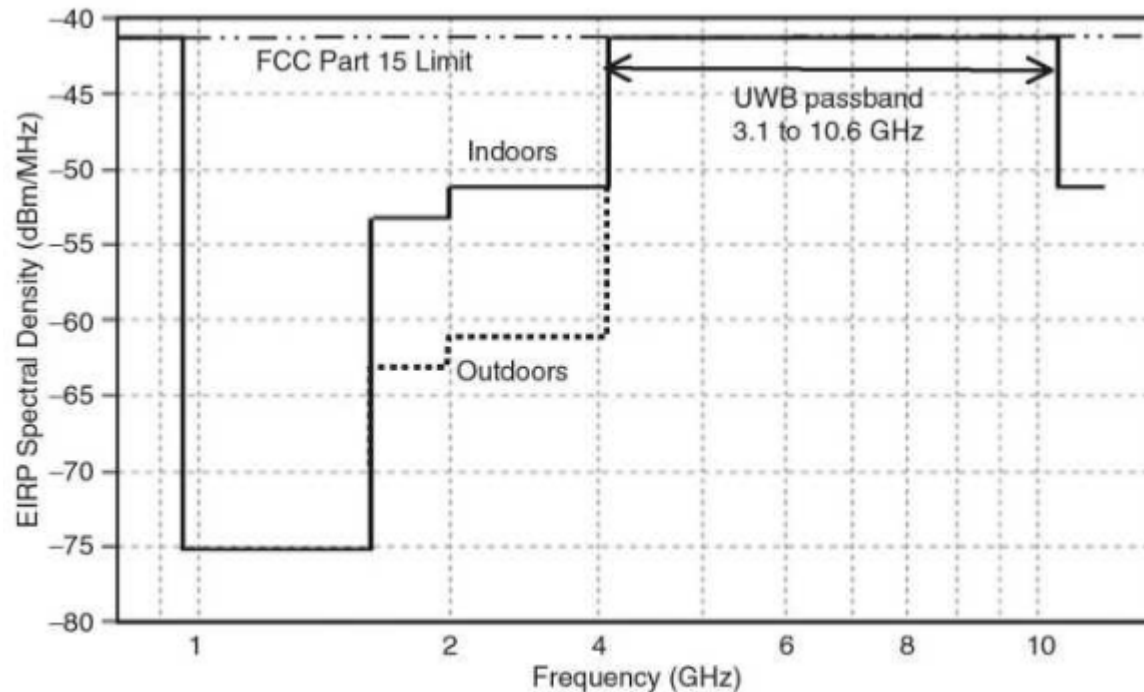
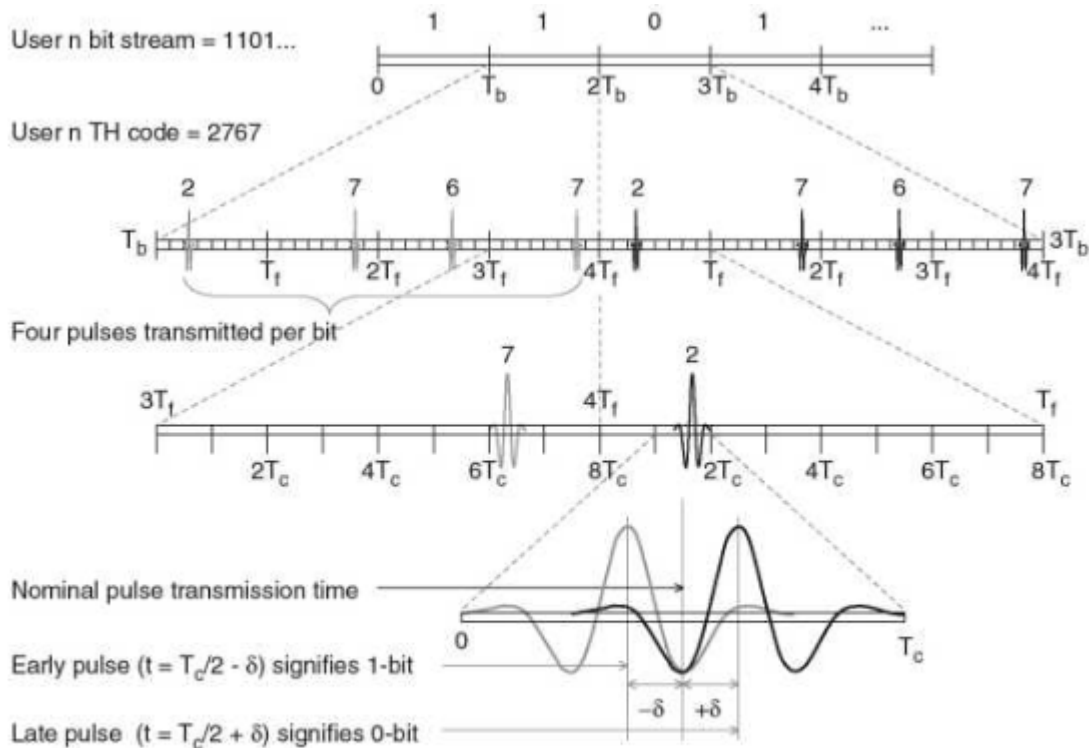

Figure 4-34: FCC UWB Passband Specification

# Ultra Wideband Radio

## ▶ Time Hopping PPM UWB (Impulse Radio)



TH code determines time hopping pattern

early/late pulse position (PPM) signifies 1 or 0

Figure 4-35: Pulse Train in a TH-PPM Impulse Radio Transmission

used in IEEE 802.15.4

# Ultra Wideband Radio

## ▶ Multiband UWB

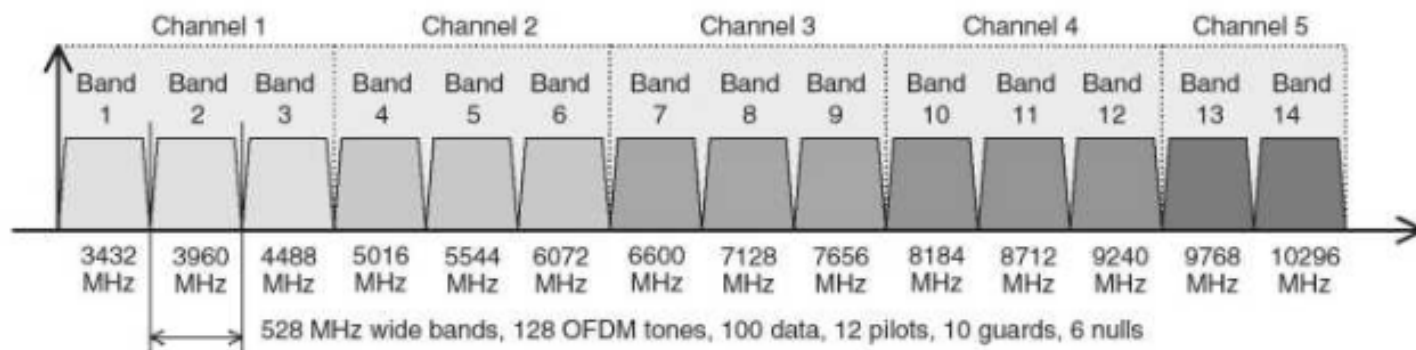

**Figure 4-36: MB-OFDM Frequency Bands and Channels**

- Within each 528MHz band, 128 OFDM subcarriers are transmitted.
- Time-frequency interleaving (TFI) code defines frequency hopping within a band group.
- Fixed frequency interleaving (FFI) code defines continuous transmission on a single OFDM band.

used in Wireless USB



# Chapter 4

## Radio Communication Basics



MIMO Radio

# MIMO Radio

---

- ▶ Multiple-input multiple-output (MIMO)
  - ▶ sends multiple data streams across multiple transmitter to receiver paths in order to achieve higher data capacity.
  - ▶ carries data in parallel on different spatial paths and on the same frequency (SDM: spatial division multiplexing).
  - ▶ can increase data capacity linearly with the number of independent paths (minimum of M transmitters and N receivers).
  - ▶ characterizes each path by estimating its singular value by using a training period (CSI: channel state information).

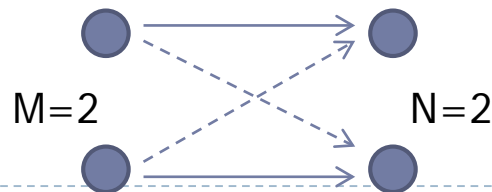

used in IEEE 802.11n

---



# MIMO Radio

## ► Multiple-input multiple-output

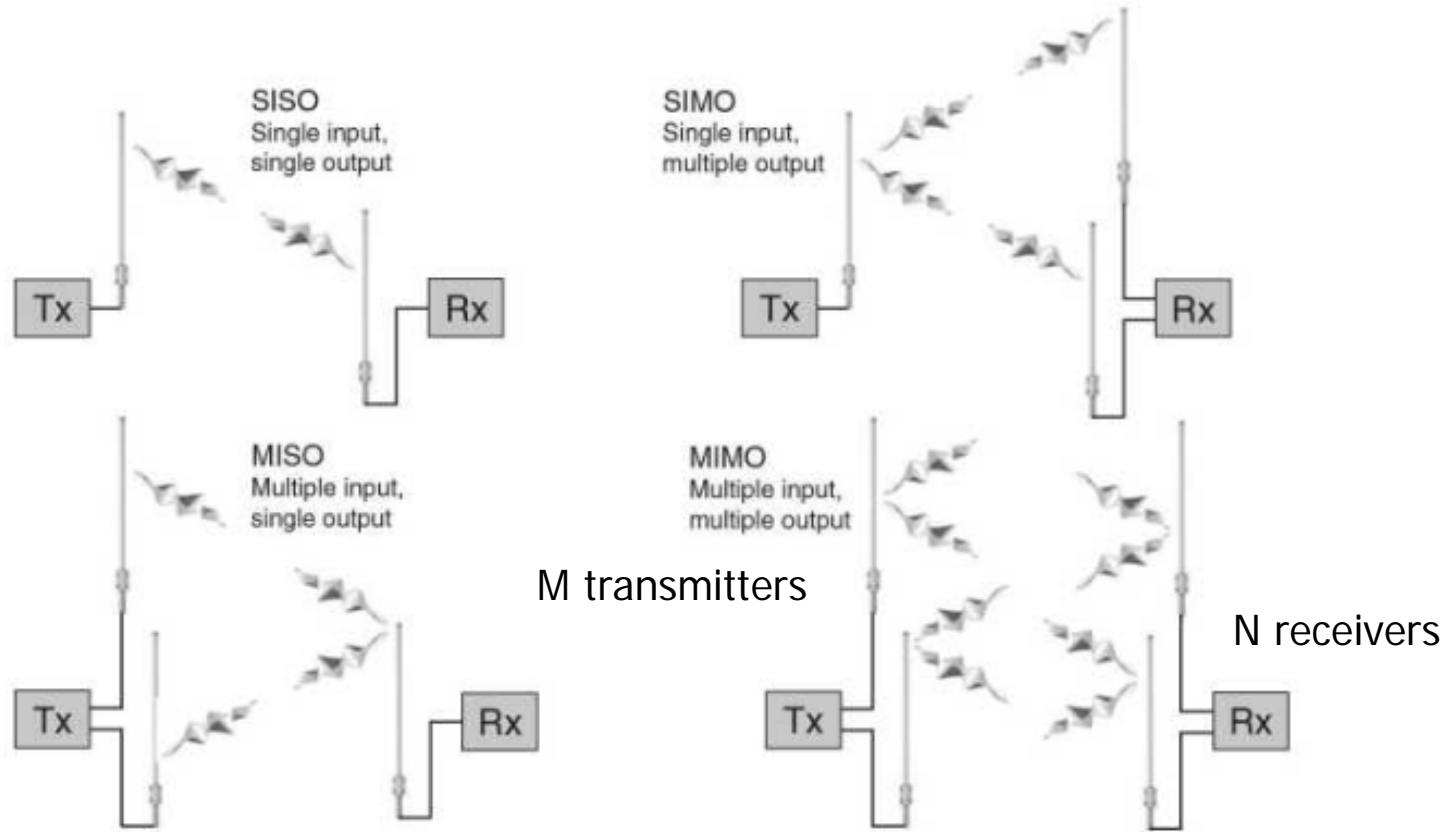

Figure 4-37: MIMO Radio Definition



# Chapter 4

## Radio Communication Basics



Near Field Communications

# Near Field Communication

---

- ▶ Near field communication (NFC)
  - ▶ is a very short range radio communication.
  - ▶ relies on direct magnetic field coupling between transmitter and receiver devices.
  
- ▶ two types of NFC devices
  - ▶ active device
    - has an internal power source
  - ▶ passive device
    - derives power by inductive coupling with an active device
    - transfers data to an active device by “load modulation”

used in SUICA, PASMO, etc. in Japan

---





# Near Field Communication

## ▶ Inductive Coupling and Load Modulation

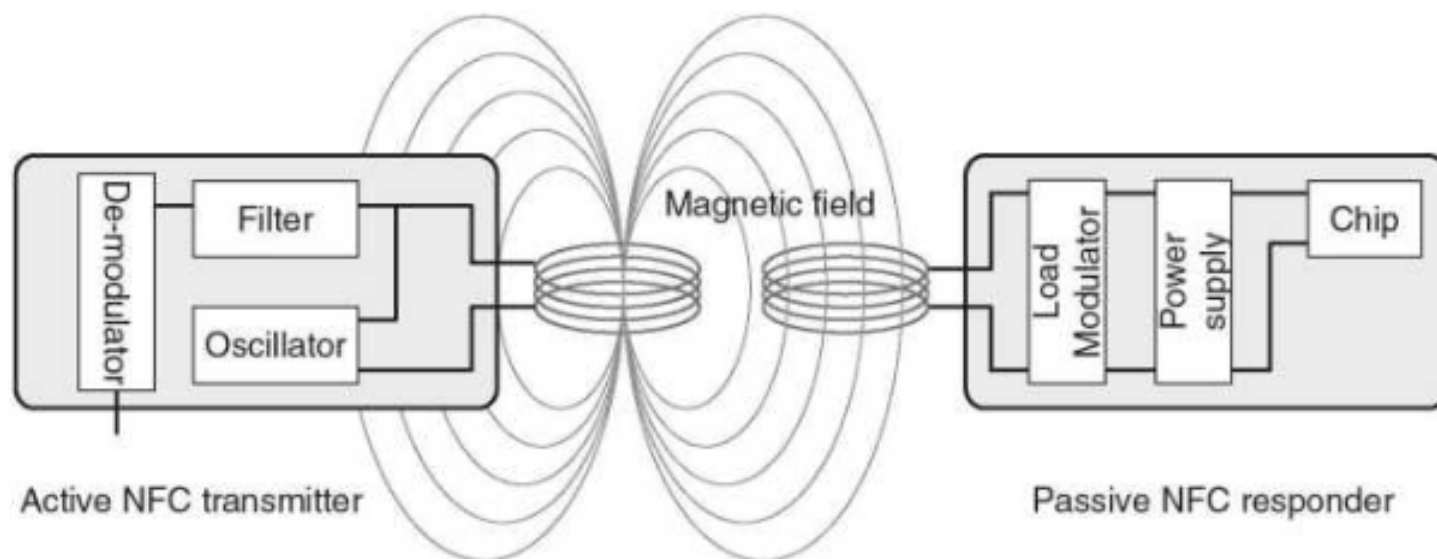

**Figure 4-38: Inductive Coupling Between NFC Antenna Loops**

- On/off switching of a load resistance at the responder causes voltage change in the transmitter's carrier wave.
- This "load modulation" creates amplitude modulated sidebands.